



Crevalle 33 CSF

Owner's Manual



TABLE OF CONTENTS

TABLE OF CONTENTS	3
SAFETY INFORMATION	7
BOAT INFORMATION	9
INTRODUCTION & IMPORTANT INFORMATION	11
OWNER / OPERATOR INFORMATION	13

Chapter 1:

SAFETY EQUIPMENT

1.1 General	15
1.2 Engine Alarms	15
1.3 Neutral Safety Switch	15
1.4 Engine Stop Switch	15
1.5 Required Safety Equipment	16
1.6 Bilge & Fuel Fires	17
1.7 First Aid	18
1.8 Additional Safety Equipment	18
1.9 Caution & Warning Labels.....	20

Chapter 2:

OPERATION

2.1 General	21
2.2 Rules of the Road	21
2.3 Pre-Cruise Check	24
2.4 Operating Your Boat	25
2.5 Docking, Anchoring & Mooring	26
2.6 Controls, Steering, or Propulsion System Failure.....	28
2.7 Collision.....	28
2.8 Grounding, Towing & Rendering Assistance	29
2.9 Flooding or Capsizing.....	29
2.10 Fishing.....	29
2.11 Man Overboard	30
2.12 Water Skiing & Wakeboarding	30
2.13 Trash Disposal	32
2.14 Yacht Certification Plate.....	32
2.15 Trailering Your Boat	33

Chapter 3:

PROPULSION SYSTEM

3.1 General	35
3.2 Drive System Corrosion	35
3.3 Engine Lubrication.....	36
3.4 Engine Cooling System	36
3.5 Propellers	36
3.6 Performance Issues & Propellers	36
3.7 Engine Instrumentation	38

TABLE OF CONTENTS

Chapter 4:

HELM CONTROL SYSTEMS

4.1 General	41
4.2 Engine Throttle & Shift Controls	41
4.3 Neutral Safety Switch	42
4.4 Engine Power Tilt & Trim	43
4.5 Engine Stop Switch	44
4.6 Steering System	45
4.7 Joystick Controls	47
4.8 Trim Tabs	48
4.9 Control Systems Maintenance	49

Chapter 5:

FUEL SYSTEM

5.1 Gasoline Fuel Systems	51
5.2 Engine Fuel Delivery System	52
5.3 Fueling Instructions	53
5.4 Fuel System Maintenance	54

Chapter 6:

ELECTRICAL SYSTEM

6.1 General	55
6.2 12 Volt DC System	55
6.3 Batteries & Battery Switches	56
6.4 Parallel Switch & Dead Batteries	57
6.5 Ignition Switch Panels	58
6.6 12 volt Accessory Switch Panels	60
6.7 DC Circuit Breakers	66
6.8 Engine Control Systems Circuit Protection	67
6.9 Accessory Fuse Panels	67
6.10 Digital Switching System Circuit Protection	68
6.11 36 volt Trolling Motor System	69
6.12 DC Power Management	70
6.13 120 Volt Battery Charging System	71
6.14 Electrical System Maintenance	73

Chapter 7:

FRESH WATER SYSTEM

7.1 General	75
7.2 Fresh Water System Operation	75
7.3 Fresh Water System Maintenance	77

Chapter 8:

RAW WATER SYSTEM

8.1 General	79
8.2 Priming the System	79
8.3 Raw Water System Operation	80
8.4 Livewells	81
8.5 Raw Water System Maintenance	82

TABLE OF CONTENTS

Chapter 9:

DRAINAGE SYSTEM

9.1 General	85
9.2 Cockpit & Deck Drainage	85
9.3 Bilge Drainage	86
9.4 Hardtop Drains	88
9.5 Head Compartment Drains	88
9.6 Drainage System Maintenance	88

Chapter 10:

VENTILATION SYSTEM

10.1 Head Compartment Ventilation	89
10.2 Windshield Ventilation	90
10.3 Maintenance	90

Chapter 11:

EXTERIOR EQUIPMENT

11.1 Deck Rails & Deck Hardware	91
11.2 Anchor & Rope Locker	92
11.3 Windlass & Bow Roller	93
11.4 Hull	95
11.5 Cockpit Features	97
11.6 Helm Seats & Tackle Prep Station	105
11.7 Center Console	107
11.8 Hardtop	109
11.9 Aftermarket Hardtop or Tower	110

Chapter 12:

INTERIOR EQUIPMENT

12.1 Head Compartment	111
12.2 Porcelain Marine Toilet	113
12.3 Head System Holding Tank	114

Chapter 13:

ROUTINE MAINTENANCE

13.1 Exterior Hull & Deck	117
12.2 Upholstery, Canvas & Enclosures	120
12.3 Interior	122
12.4 Bilge, Pumps & Components	122
12.5 Engine & Fuel	123
12.6 Drainage System	123

Chapter 14:

SEASONAL MAINTENANCE

14.1 Storage & Lay-up	125
14.2 Freshwater System Winterizing	126
14.3 Raw Water System Winterizing	127
14.4 Recommissioning	129

TABLE OF CONTENTS

Appendix A:

SCHEMATICS	131
Viewing Your Drawing Set	131
Seastar DCM.....	132
DCM/ Wet Sounds Assembly 1.....	133
DCM/ Wet sounds Assembly 2	134
DCM/ JL Audio Assembly 1.....	135
DCM/ JL Audio Assembly 2.....	136
MDP Battery Switch Panel	137
Hull Harness	138
Port Deck Harness	139
Starboard Deck Harness	140
Hardtop Harness	141
Console Harness.....	142
Helm Switch Panel	143
Speaker Connector Harness Kit	144
Trim Tab Interface Harness	145

Appendix B:

DCM User Manual & Trouble Shooting Guide	147
------------------------------------------------	-----

Appendix C:

MAINTENANCE LOG	167
-----------------------	-----

Appendix D:

BOATING ACCIDENT REPORT	169
-------------------------------	-----

Appendix E:

FLOAT PLAN.....	173
-----------------	-----

Appendix F:

GLOSSARY OF TERMS	175
-------------------------	-----

Appendix G:

TROUBLESHOOTING GUIDE	181
-----------------------------	-----

Appendix H:

SPECIFICATIONS	185
----------------------	-----

State of California Safety Requirements



WARNING



PROPOSITION 65

OPERATING, SERVICING AND MAINTAINING A RECREATIONAL MARINE VESSEL CAN EXPOSE YOU TO CHEMICALS INCLUDING ENGINE EXHAUST, CARBON MONOXIDE, PHTHALATES, AND LEAD, WHICH ARE KNOWN TO THE STATE OF CALIFORNIA TO CAUSE CANCER AND BIRTH DEFECTS OR OTHER REPRODUCTIVE HARM. TO MINIMIZE EXPOSURE, AVOID BREATHING EXHAUST, SERVICE YOUR VESSEL IN A WELL-VENTILATED AREA AND WEAR GLOVES OR WASH YOUR HANDS FREQUENTLY WHEN SERVICING THIS VESSEL. FOR MORE INFORMATION GO TO WWW.P65WARNING.CA.GOV/MARINE.

California Health & Safety Code §§ 25249.5-.13

State of California Emission Requirements

Your boat may be equipped with an engine that meets the special requirements outlined by the California Air Resources Board (CARB). If so, the engine is designed to meet strict requirements and the boat will have a special tag and one of the following labels affixed to it.

The tag and the label are required by CARB. The label has 1, 2, 3 or 4 stars and must be affixed to your boat if it is to be operated in the state of California and/or bordering waters. For more information visit: <http://www.arb.ca.gov>.



SAFETY INFORMATION

Your Crevalle owner's manual has been written to include a number of safety instructions to assure the safe operation and maintenance of your boat. These instructions are in the form of **DANGER**, **WARNING** and **CAUTION** statements. The following definitions apply:

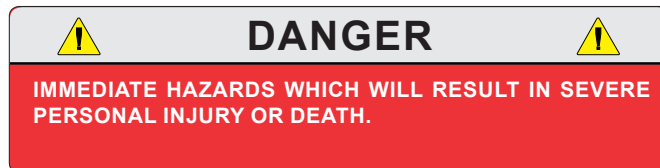

All instructions given in this book are as seen from the stern looking toward the bow, with starboard being to your right and port to your left. A glossary of boating terms is included.

IMPORTANT NOTE: Your boat uses an internal combustion engine and flammable fuel. Every precaution has been taken by Crevalle to reduce the risks associated with possible injury and damage from fire or explosion, but your own precaution and good maintenance procedures are necessary in order to enjoy safe operation of your boat.

BOAT INFORMATION

Please fill out the following information section and leave it in your Crevalle owner's manual. This information will be important for you, your dealer and/or Crevalle service personnel to know, if you may need to call them for technical assistance or service.

BOAT			
MODEL:		HULL SERIAL #:	
PURCHASE DATE:		DELIVERY DATE:	
IGNITION KEYS #:		REGISTRATION #:	
WEIGHT:	DRAFT:	BEAM:	VERTICAL CLEARANCE:
DOOR KEYS #:			
ENGINES			
MAKE:		MODEL:	
PORT SERIAL #:		STARBOARD SERIAL #:	
TRAILER			
MAKE:		MODEL:	
SERIAL #:		GVWR:	
TIRE SIZE:			
OPTIONS			
PROPELLERS			
MAKE:		BLADES:	
DIAMETER/PITCH:		SHAFT:	
NOTES			
DEALER		CREVALLE	
NAME:		PHONE:	
DEALER/PHONE:		REPRESENTATIVE:	
SALESMAN:		ADDRESS:	
SERVICE MANAGER:			
ADDRESS:			
DEALER E-MAIL:		E-MAIL:	

All information, illustrations and specifications contained in this manual are based on the latest product information available at the time of publication. Crevalle Boats reserves the right to make changes at anytime, without notice, in colors, materials, equipment, specifications and models.

NOTES

INTRODUCTION & IMPORTANT INFORMATION

All instructions given in this book are as seen from the stern looking toward the bow with starboard being to your right and port to your left. The information and precautions listed in this manual are not all inclusive. It may be general in nature in some cases and detailed in others and is designed to provide you a basic understanding of your Crevalle boat and some of the responsibilities that go along with owning/operating your boat.

The suppliers of some of the major components such as the engines, pumps and appliances, provide their own owner's manuals which have been included with your boat. You should read the information in this manual and the manuals of other suppliers completely and have a thorough understanding of all component systems and their proper operation before operating your boat.

REMEMBER - IT IS YOUR RESPONSIBILITY TO ENSURE THAT YOUR BOAT IS SAFE FOR YOU AND YOUR PASSENGERS. ALWAYS EXERCISE GOOD COMMON SENSE WHEN INSTALLING EQUIPMENT AND OPERATING THE BOAT.

Warranty And Warranty Registration Cards

The Crevalle Limited Warranty Statement is included with your boat. It has been written to be clearly stated and easily understood. If you have any questions after reading the warranty, please contact the Crevalle Boats Customer Service Department

Crevalle, engine manufacturers and the suppliers of major components maintain their own manufacturer's warranty and service facilities. It is important that you properly complete the warranty registration cards included with your boat and engine and mail them back to the manufacturer to register your ownership. This should be done within 15 days of the date of purchase and before the boat is put into service. A form for recording this information for your records is provided at the beginning of this manual. This information will be important for you and service personnel to know, if and when you may need service or technical information.

The boat warranty registration requires the **Hull Identification Number "HIN"** which is located on the starboard side of the transom, just below the rubrail. The engine warranty registration requires the engine serial numbers. Please refer to the engine owner's manual for the location of the serial numbers.

IMPORTANT:

The terms and conditions of the Crevalle Boats Limited Warranty are outlined in the warranty statement included with this manual. The manufacturer will automatically honor the warranty to the original purchaser for 15 days from the date of purchase. However, during that 15 day period, owners must comply with the steps outlined in the warranty statement to validate their warranty.

All boat manufacturers are required by the Federal Boat Safety Act of 1971 to notify first time owners in the event any defect is discovered "which creates a substantial risk of personal injury to the public." ***It is essential that we have your warranty registration card complete with your name and mailing address in our files so that we can comply with the law if it should become necessary.***

Your Crevalle Boats Dealer will assist you in filling in the hull number and other data required on your Registration Card. Check to see that your card is complete and signed. Detach and mail. Your Warranty Registration Card will be added to our permanent files.

Transferring the Limited Structural Warranty

For a transfer fee, Crevalle Boats will offer to extend a Transferable Limited Structural Hull Warranty to subsequent owners of Crevalle Boats. Please refer to the Crevalle Limited Warranty Statement for the terms and conditions of the Transferable Limited Structural Hull Warranty and the procedure to transfer the warranty.

Product Changes

Crevalle is committed to the continuous improvement of our boats. As a result, some of the equipment described in this manual or pictured in the catalog may change or no longer be available. ***All information, illustrations and specifications contained in this manual are based on the latest product information available at the time of publication. Crevalle Boats reserves the right to make changes at anytime, without notice, in colors, materials, equipment, specifications and models.*** If you have questions about the equipment on your Crevalle, please contact the Crevalle Boats Customer Service Department.

INTRODUCTION & IMPORTANT INFORMATION

Service

All warranty repairs must be performed by an authorized Crevalle Dealer. Should a problem develop that is related to faulty workmanship or materials, as stated in the Limited Warranty, you should contact your Crevalle dealer to arrange for the necessary repair. If you are not near your dealer or another authorized Crevalle dealer or the

dealer fails to remedy the cause of the problem, then contact Crevalle within 15 days.

Crevalle will not reimburse boat owners for warranty repairs performed without prior authorization provided in writing.

It is the boat owner's responsibility to deliver the boat to the dealer for warranty service.

Registration And Numbering

Federal law requires that all undocumented vessels equipped with propulsion machinery be registered in the State of principal use. A certificate of number will be issued upon registering the boat. These numbers must be displayed on your boat. The owner/operator of a boat must carry a valid certificate of number whenever the boat is in use. When moved to a new State of principal use, the certificate is valid for 60 days.

In order to be valid, the numbers must be installed to the proper specifications. Check with your dealer or state boating authority for numbering requirements. The Coast Guard issues the certificate of number in Alaska; all others are issued by the state.

Insurance

In most States the boat owner is legally responsible for damages or injuries he or someone else operating the boat causes. Responsible boaters carry adequate liability and property damage insurance for their boat. You should also protect the boat against physical damage and theft. Some States have laws requiring minimum insurance coverage. Contact your dealer or state boating authority for information on the insurance requirements in your boating area.

Reporting Boating Accidents

All boating accidents must be reported by the operator or owner of the boat to the proper marine law enforcement authority for the state in which the accident occurred. Immediate notification is required if a person dies or disappears as a result of a recreational boating accident.

If a person dies or there are injuries requiring more than first aid, a formal report must be filed within 48 hours.

A formal report must be made within 10 days for accidents involving more than \$500.00 damage or the complete loss of a boat.

A Boating Accident Report form is located near the back of this manual to assist you in reporting an accident. If you need additional information regarding accident reporting, please call the Boating Safety Hotline, 800-368-5647.

Education

If you are not an experienced boater, we recommend that the boat operator and other people that normally accompany the operator, enroll in a boating safety course. Organizations such as the U.S. Power Squadrons, United States Coast Guard Auxiliary, State Boating Authorities and the American Red Cross offer excellent boating educational programs. These courses are worthwhile even for experienced boaters to sharpen your skills or bring you up to date on current rules and regulations. They can also help in providing local navigational information when moving to a new boating area. Contact your dealer, State Boating Authority or the Boating Safety Hotline, 800-368-5647 for further information on boating safety courses.

Required Equipment

U.S. Coast Guard regulations require certain equipment on each boat. The Coast Guard also sets minimum safety standards for vessels and associated equipment. To meet these standards some of the equipment must be Coast Guard approved. "Coast Guard Approved Equipment" has been determined to be in compliance with USCG specifications and regulations relating to performance, construction or materials. The equipment requirements vary according to the length, type of boat and the propulsion system. Some of the Coast Guard equipment is described in the Safety Equipment chapter of this manual. For a more detailed description, obtain "Federal Requirements And Safety Tips For Recreational Boats" by contacting the Boating Safety Hotline 800-368-5647 or your local marine dealer or retailer.

Some state and local agencies impose similar equipment requirements on waters that do not fall under Coast Guard jurisdiction. These agencies may also require additional equipment that is not required by the Coast Guard. Your dealer or local boating authority can provide you with additional information for the equipment requirements for your boating area.

NOTES

Chapter 1:

SAFETY EQUIPMENT

1.1 General

Your boat and outboard engines have been equipped with safety equipment designed to enhance the safe operation of the boat and to meet U.S. Coast Guard safety standards. The Coast Guard or state, county and municipal law enforcement agencies require certain additional accessory safety equipment on each boat. This equipment varies according to length and type of boat and type of propulsion. The accessory equipment typically required by the Coast Guard is described in this chapter. Some local laws require additional equipment. It is important to obtain "Federal Requirements And Safety Tips for Recreational Boats," published by the Coast Guard and copies of state and local laws, to make sure you have the required equipment for your boating area.

Your boat is equipped with engine alarms. The alarm systems are designed to increase your boating safety by alerting you to potentially serious problems in the primary power system. Alarm systems are not intended to lessen or replace good maintenance and pre-cruise procedures.

This chapter also describes safety related equipment that could be installed on your boat. This equipment will vary depending on the type of engines and other options installed by you or your dealer.

1.2 Engine Alarms

Most outboard engines are equipped with an audible alarm system mounted in the helm area that monitors selected critical engine systems. The alarm will sound if one of these systems begins to fail. Refer to the engine owner's manual for information on the alarms installed with your engines.

If the alarm sounds:

- Immediately throttle the engines back to idle.
- Shift the transmissions to neutral.
- Monitor the engine gauges to determine the cause of the problem.
- If necessary, shut off the engine and investigate until the cause of the problem is found.



Throwable Device & Personal PFD

1.3 Neutral Safety Switch

Every control system has a neutral safety switch incorporated into it. This device prohibits the engines from being started while the shift levers are in any position other than the neutral position. If an engine will not start, slight movement of the shift lever may be necessary to locate the neutral position and disengage the safety cutout switch. Control adjustments may be required to correct this condition should it persist. See your Crevalle dealer for necessary control adjustments. Please refer to the Helm Control Systems chapter for more information on the neutral safety switch.

1.4 Engine Stop Switch

Your boat is equipped with an engine stop switch and lanyard. When the lanyard is pulled it will engage the switch and shut off the engines. We strongly recommend that the lanyard be attached to the driver and the stop switch whenever the engines are running. If the engines will not start, it could be because the lanyard is not properly inserted into the engine stop switch. Always make sure the lanyard is properly attached to the engine stop switch before attempting to start the engine.

Notice:

In some states, a lanyard attached to the driver at all times is required by law.

Safety Equipment

Notice:

You should carry an extra stop switch lanyard and instruct at least one other crew member on the operation of the stop switch and location of the extra lanyard.

1.5 Required Safety Equipment

Besides the equipment installed on your boat by Crevalle, certain other equipment is required by the U.S. Coast Guard to help ensure passenger safety. Items like a sea anchor, working anchor, extra dock lines, flare pistol, life vests, a line permanently secured to your ring buoy, etc., could at some time save your passengers' lives or save your boat from damage. Refer to the "Federal Requirements And Safety Tips For Recreational Boats" pamphlet for a more detailed description of required equipment. You also can contact the Coast Guard Auxiliary for information on boat safety courses and brochures listing the Federal equipment requirements. Also, check your local and state regulations.

The Coast Guard Auxiliary offers a "Courtesy Examination." This inspection will help ensure that your boat is equipped with all of the necessary safety equipment. The following is a list of the accessory equipment required on your boat by the U.S. Coast Guard:

Personal Flotation Devices (PFDs)

PFDs must be Coast Guard approved, in good and serviceable condition and of appropriate size for the intended user. Wearable PFDs must be readily accessible, meaning you must be able to put them on in a reasonable amount of time in an emergency. Though not required, the Coast Guard emphasizes that PFDs should be worn at all times when the vessel is underway. Throwable devices must be immediately available for use. All Crevalle boats must be equipped with at least one Type I, II or III PFD for each person onboard, plus one throwable device (Type IV).

Notice:

Many state laws now require that children 13 years old and under must wear a PFD at all times.

Anyone being towed on skis, wakeboards and other water sports equipment is considered a passenger on the boat and must wear a Coast Guard approved life jacket at all times.



Visual Distress Signals

All boats used on coastal waters, the Great Lakes, territorial seas and those waters connected directly to them, must be equipped with Coast Guard approved visual distress signals. These signals are either Pyrotechnic or Non-Pyrotechnic devices.

Pyrotechnic Visual Distress Signals:

Pyrotechnic visual distress signals must be Coast Guard approved, in serviceable condition and readily accessible. They are marked with a date showing the service life, which must not have expired. A minimum of three are required. Some pyrotechnic signals meet both day and night use requirements. They should be stored in a cool, dry location. They include:

- Pyrotechnic red flares, hand held or aerial.
- Pyrotechnic orange smoke, hand-held or floating.
- Launchers for aerial red meteors or parachute flares.

 **WARNING** 

PYROTECHNICS ARE UNIVERSALLY RECOGNIZED AS EXCELLENT DISTRESS SIGNALS. HOWEVER, THERE IS POTENTIAL FOR INJURY AND PROPERTY DAMAGE IF NOT PROPERLY HANDLED. THESE DEVICES PRODUCE A VERY HOT FLAME AND THE RESIDUE CAN CAUSE BURNS AND IGNITE FLAMMABLE MATERIAL. PISTOL LAUNCHED AND HAND-HELD PARACHUTE FLARES AND METEORS HAVE MANY CHARACTERISTICS OF A FIREARM AND MUST BE HANDLED WITH CAUTION. IN SOME STATES THEY ARE CONSIDERED A FIREARM AND PROHIBITED FROM USE. ALWAYS BE EXTREMELY CAREFUL AND FOLLOW THE MANUFACTURER'S INSTRUCTIONS EXACTLY WHEN USING PYROTECHNIC DISTRESS SIGNALS.

Non-Pyrotechnic Devices

Non-Pyrotechnic visual distress signals must be in serviceable condition, readily accessible, and certified by the manufacturer as complying with U.S. Coast Guard requirements. They include:

- **Orange Distress Flag (Day use only)**
The distress flag is a day signal only. It must be at least 3 x 3 feet with a black square and ball on an orange background. It is most distinctive when attached and waved from a paddle or boat hook.

- **Electric Distress Light (Night use only)**
The electric distress light is accepted for night use only and must automatically flash the international SOS distress signal. Under "Inland Navigation Rules," a high intensity white light flashing at regular intervals from 50-70 times per minute is considered a distress signal.

Sound Signaling Devices

The navigation rules require sound signals to be made under certain circumstances. Recreational vessels also are required to sound fog signals during periods of reduced visibility. Therefore, you must have some means of making an efficient sound signal.

Navigation Lights

Recreational boats are required to display navigation lights between sunset and sunrise and other periods of reduced visibility (fog, rain, haze, etc.) Navigation lights are intended to keep other vessels informed of your presence and course. Your boat is equipped with navigation lights required by the U.S. Coast Guard at the time of manufacture. It is up to you to make sure they are operational and turned on when required.

Fire Extinguishers

Boats over 26 feet are required to carry one or two fire extinguishers, depending on the type of fire extinguishers used. Coast Guard approved fire extinguishers are hand-portable, either B-I or B-II classification and have a specific marine type mounting bracket. It is recommended that the extinguishers be mounted in a readily accessible position.



Fire extinguishers require regular inspections to ensure that:

- Seals & tamper indicators are not broken or missing.
- Pressure gauges or indicators read in the operable range.
- There is no obvious physical damage, corrosion, leakage or clogged nozzles.

Refer to the "Federal Requirements And Safety

Tips For Recreational Boats" pamphlet or contact the Coast Guard Auxiliary, for information on the type and size fire extinguisher required for your boat.

Refer to the information provided by the fire extinguisher manufacturer for instructions on the proper maintenance and use of your fire extinguisher.

CAUTION

INFORMATION FOR HALON, AGENT FE-241 AND AGENT FM 200 FIRE EXTINGUISHERS IS PROVIDED BY THE MANUFACTURER. IT IS ESSENTIAL THAT YOU READ THE INFORMATION CAREFULLY AND COMPLETELY UNDERSTAND THE SYSTEM, IN THEORY AND OPERATION, BEFORE USING YOUR BOAT.

1.6 Bilge & Fuel Fires

Fuel compartment and bilge fires are very dangerous because of the presence of gasoline in the various components of the fuel system and the possibility for explosion. You must make the decision to fight the fire or abandon the boat. If the fire cannot be extinguished quickly or it is too intense to fight, abandoning the boat may be your only option. If you find yourself in this situation, make sure all passengers have a life preserver on and go over the side and swim well upwind of the boat. This will keep you and your passengers well clear of any burning fuel that could be released and spread on the water as the boat burns or in the event of an explosion. When clear of the danger, check about and account for all those who were aboard with you. Give whatever assistance you can to anyone in need or in the water without a buoyant device. Keep everyone together in a group for morale and to aid rescue operations.

WARNING

GASOLINE CAN EXPLODE. IN THE EVENT OF A FUEL COMPARTMENT OR BILGE FIRE, YOU MUST MAKE THE DIFFICULT DECISION TO FIGHT THE FIRE OR ABANDON THE BOAT. YOU MUST CONSIDER YOUR SAFETY, THE SAFETY OF YOUR PASSENGERS, THE INTENSITY OF THE FIRE AND THE POSSIBILITY OF AN EXPLOSION IN YOUR DECISION.

Safety Equipment



Typical First Aid Kit

1.7 First Aid

It is the operator's responsibility to be familiar with the proper first-aid procedures and be able to care for minor injuries or illnesses of your passengers. In an emergency, you could be far from professional medical assistance. We strongly recommend that you be prepared by receiving training in basic first aid and CPR. This can be done through classes given by the Red Cross or your local hospital.

Your boat should also be equipped with at least a simple marine first-aid kit and a first-aid manual. The marine first-aid kit should be designed for the marine environment and be well supplied. It should be accessible and each person onboard should be aware of its location. As supplies are used, replace them promptly. Some common drugs and antiseptics may lose their strength or become unstable as they age. Ask a medical professional about the supplies you should carry and the safe shelf life of prescription drugs or other medical supplies that may be in your first-aid kit. Replace questionably old supplies whether they have been used or not.

In many emergency situations, the Coast Guard can provide assistance in obtaining medical advice for treatment of serious injuries or illness. If you are within VHF range of a Coast Guard Station, make the initial contact on channel 16 and follow their instructions.

1.8 Additional Safety Equipment

Besides meeting the legal requirements, prudent boaters carry additional safety equipment. This is particularly important if you operate your boat offshore. You should consider the following items, depending on how you use your boat.

Satellite EPIRBs

EPIRBs (Emergency Position Indicating Radio Beacon) operate as part of a worldwide distress system. When activated, EPIRBs will send distress code homing beacons that allow Coast Guard aircraft to identify and find them quickly. The satellites that receive and relay EPIRB signals are operated by the National Oceanic and Atmospheric Administration (NOAA) in the United States. The EPIRB should be mounted and registered according to the instructions provided with the beacon,

so that the beacon's unique distress code can be used to quickly identify the boat and owner.

Marine Radio

A marine radio is the most effective method of receiving information and requesting assistance. VHF marine radios are used near shore and single sideband radios are used for long range communication.

There are specific frequencies to use in an emergency. The VHF emergency channel is 16 in the United States. You should read the owners manual for your radio and know how to use it in an emergency or for normal operation. If you hear a distress call you should assist or monitor the situation until help is provided.

Additional Equipment to Consider:

Cell Phone	Spare Anchor
Fenders	Heaving Line
Mirror	First Aid Kit
Tool Kit	Flashlight & Batteries
Anchor	Search light
Boat Hook	Sunburn Lotion
Mooring Lines	Ring Buoy or Boat Cushion
Binoculars	Whistle or Horn
Extra Clothing	Marine Hardware
Chart and Compass	Spare Keys
Food & Water	Spare Parts
Sunglasses	Spare Propeller Hub Kits
Spare Propellers	

Safety Equipment

1.9 Caution & Warning Labels

The caution and warning labels shown are examples of the labels that could be on your boat. The actual labels and their location could vary on your boat.

Caution and warning labels must remain legible for the safety of you and your passengers. If a label becomes missing or damaged it must be replaced. Immediately contact your dealer or Crevalle Customer Service for a replacement.



⚠ DANGER ⚠
ROTATING PROPELLER MAY CAUSE SERIOUS INJURY OR DEATH. SHUT OFF ENGINE WHEN NEAR PERSONS IN THE WATER.

⚠ DANGER ⚠
ROTATING PROPELLER MAY CAUSE SERIOUS INJURY OR DEATH.
DO NOT APPROACH OR USE LADDER WHEN ENGINE IS RUNNING.

⚠ DANGER ⚠
CARBON MONOXIDE (CO) CAN CAUSE BRAIN DAMAGE OR DEATH.
ENGINE AND GENERATOR EXHAUST CONTAINS ODORLESS AND COLORLESS MONOXIDE GAS.
CARBON MONOXIDE WILL BE AROUND THE BACK OF THE BOAT WHEN THE ENGINES OR GENERATORS ARE RUNNING.
MOVE TO FRESH AIR, IF YOU FEEL NAUSEA, HEADACHE, DISSINESS, OR DROWSINESS.

⚠ WARNING ⚠
CARBON MONOXIDE (CO) CAN CAUSE BRAIN DAMAGE OR DEATH.
ENGINE AND GENERATOR EXHAUST CONTAINS ODORLESS AND COLORLESS CARBON MONOXIDE GAS.
SIGNS OF CARBON MONOXIDE POISONING INCLUDE NAUSEA, HEADACHE, DIZZINESS, DROWSINESS, AND LACK OF CONSCIOUSNESS.
GET FRESH AIR IF ANYONE SHOWS SIGNS OF CARBON MONOXIDE POISONING.
SEE OWNER'S MANUAL FOR INFORMATION REGARDING CARBON MONOXIDE POISONING.

⚠ WARNING ⚠
AVOID SERIOUS INJURY OR DEATH FROM FIRE OR EXPLOSION RESULTING FROM LEAKING FUEL. INSPECT SYSTEM FOR LEAKS AT LEAST ONCE A YEAR.

2.1 General

Before you start the engines on your boat, you should become familiar with the various component systems and their operation, and have performed a "Pre-Cruise System Check." A thorough understanding of the component systems and their operation is essential to the proper operation of the boat. This manual and associated manufacturers' information is provided to enhance your knowledge of your boat. Please read them carefully.

Your boat must have the necessary safety equipment onboard and be in compliance with the U.S. Coast Guard, local and state safety regulations. There should be one Personal Floatation Device (PFD) for each person. Non-swimmers and small children should wear PFDs at all times. You should know and understand the "Rules of the Road" and have had an experienced operator brief you on the general operation of your new boat. At least one other person should be instructed on the proper operation of the boat in case the operator is suddenly incapacitated.

The operator is responsible for his safety and the safety of all passengers. When boarding or loading the boat, always step onto the boat, never jump. All passengers should be properly seated whenever the boat is operated above idle speed. Your passengers should not be allowed to sit on seat backs, gunnels, bow, transom or on fishing seats whenever the boat is underway. The passengers should also be seated to properly balance the load and must not obstruct the operator's view, particularly to the front.

Overloading and improper distribution of weight can cause the boat to become unstable and are significant causes of accidents. Know the weight capacity and horsepower rating of your boat. Do not overload or overpower your boat.

You should be aware of your limitations and the limitations of your boat in different situations or sea conditions. No boat is indestructible, no matter how well it is constructed. Any boat can be severely damaged if it is operated in a manner that exceeds its design limitations. If the ride is hard on you and your passengers, it is hard on

the boat as well. Always modify the boat speed in accordance with the sea conditions, boat traffic and weather conditions.

Remember, it is the operator's responsibility to use good common sense and sound judgement in loading and operating the boat.

2.2 Rules of the Road

As in driving an automobile, there are a few rules you must know for safe boating operation. The following information describes the basic navigation rules and action to be taken by vessels in crossing, meeting or overtaking situations while operating in inland waters. These are basic examples and not intended to teach all the rules of navigation. For further information consult the "Navigation Rules" or contact the Coast Guard, Coast Guard Auxiliary, Department of Natural Resources, or your local boat club. These organizations sponsor courses in boat handling, including rules of the road. We strongly recommend such courses. Books on this subject are also available from your local library.

Notice:

Sailboats not under power, paddle boats, vessels unable to maneuver, vessels engaged in commercial fishing and other vessels without power have the right of way over motor powered boats. You must stay clear or pass to the stern of these vessels. Sailboats under power are considered motor boats.

Crossing Situations

When two motor boats are crossing, the boat on the right has the right-of-way. The boat with the right-of-way should maintain its course and speed. The other vessels should slow down and permit it to pass. The boats should sound the appropriate signals.

Meeting Head-On or Nearly-So Situations

When two motor boats are approaching each other head-on or nearly head-on, neither boat has the right-of-way. Both boats should reduce their speed and turn to the right so as to pass port side to port side, providing enough clearance for safe passage. The boats should sound the appropriate signals.

Operation

Overtaking Situations

When one motor boat is overtaking another motor boat, the boat that is being passed has the right-of-way. The overtaking boat must make the adjustments necessary to provide clearance for a safe passage of the other vessel. The boats should sound the appropriate signals.

The General Prudential Rule

In obeying the Rules of the Road, due regard must be given to all dangers of navigation and collision, and to any special circumstances, including the limitations of the vessels, which may justify a departure from the rules that is necessary to avoid immediate danger or a collision.

Night Operation

Recreational boats are required to display navigation lights between sunset and sunrise and other periods of reduced visibility such as fog, rain, haze, etc. When operating your boat at night you should:

- Make sure your navigation lights are on and working properly. Navigation lights warn others of your position and course and the position and course of other vessels.
- All navigation rules apply. If the bow light of another vessel shows red, you should give way to that vessel, if it shows green, you have the right-of-way. If you only see a white light you are either overtaking or the boat is anchored and you must give way in both cases.
- Slow down and never operate at high speeds when operating at night, stay clear of all boats and use good common sense. Always be ready to slow down or steer clear of other vessels, even if you have the right-of-way.
- Avoid bright lights that can destroy night vision, making it difficult to see navigation lights and the lights of other boats. You and your passengers should keep a sharp lookout for hazards, other boats and navigational aids.

Navigation Aids

Aids to navigation are placed along coasts and navigable waters as guides to mark safe water and to assist mariners in determining their position in relation to land and hidden dangers. Each aid to navigation is used to provide specific information. You should be familiar with these and any other markers used in your boating area.

Notice:

Storms and wave action can cause buoys to move. You should not rely on buoys alone to determine your position.

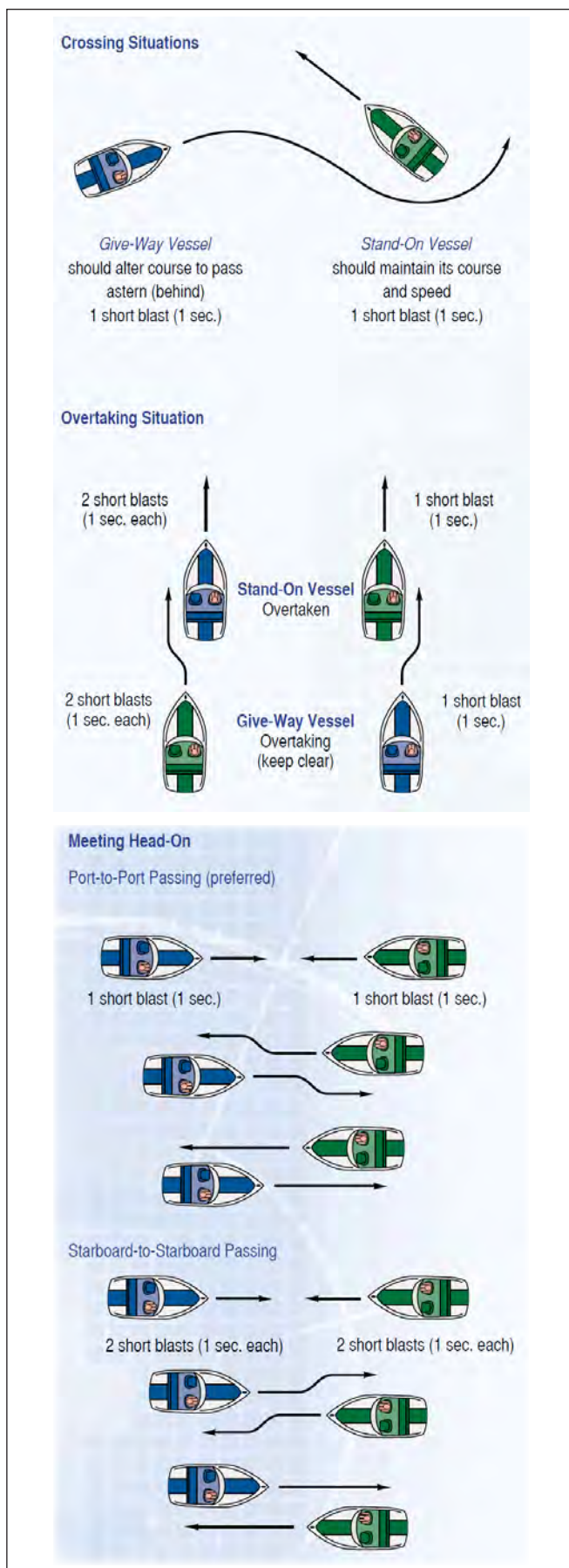

Navigational Aids Chart

REMEMBER THESE RULES

1. OVERTAKING - PASSING: Boat being passed has the right-of-way. KEEP CLEAR.
2. MEETING HEAD ON: Keep to the right.
3. CROSSING: Boat on right has the right-of-way. Slow down and permit boat to pass.

← PORT

STARBOARD →

Yield right-of-way to boats in your DANGER ZONE!

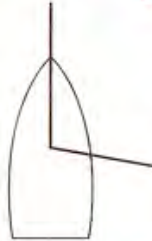

DANGER ZONE
(Dead ahead to 2 points abaft your starboard beam)

STORM WARNINGS



RED FLAG
Small craft (winds to 33 knots)



2 RED FLAGS
Gale (winds up to 47 knots)



SQUARE RED FLAG BLACK BOX
(Storm)



2 SQUARE RED FLAGS BLACK BOX
(Hurricane)

WHISTLE SIGNALS

- ONE LONG BLAST:** Warning signal (Coming out of slip)
- ONE SHORT BLAST:** Pass on my port side
- TWO SHORT BLASTS:** Pass on my starboard side
- THREE SHORT BLASTS:** Engine(s) in reverse
- FOUR OR MORE BLASTS:** Danger signal

BRIDGE SIGNALS

SOUND

- VESSEL: Open
- BRIDGE: OK
- No
- VESSEL: Replies:
- RADIO: VHF CH. 13**

VISUAL

- VESSEL: Open DAY (Flag) NIGHT (Lights)
- BRIDGE: OK Same or
- No

LATERAL AIDS AS SEEN ENTERING FROM SEAWARD

PORT SIDE ODD NUMBERED AIDS

- GREEN LIGHT ONLY
- FLASHING
- OCCULTING
- QUICK FLASHING
- ISOPHASE

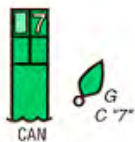
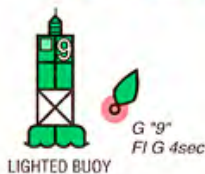

SAFE WATER MID-CHANNELS OR FAIRWAYS NO NUMBERS — MAY BE LETTERED

- WHITE LIGHT ONLY
- MORSE CODE
- Mo (A)

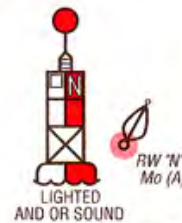

PREFERRED CHANNEL

NO NUMBERS — MAY BE LETTERED

COMPOSITE GROUP FLASHING (2 + 1)

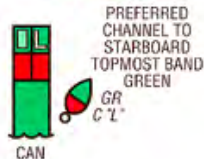
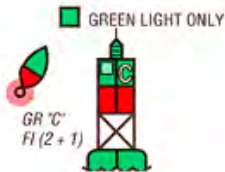

LIGHTED

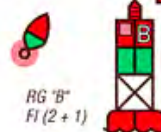

STARBOARD SIDE EVEN NUMBERED AIDS

- RED LIGHT ONLY
- FLASHING
- OCCULTING
- QUICK FLASHING
- ISOPHASE

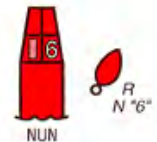



Operation

2.3 Pre-Cruise Check

Before Starting the Engines

- Check the weather forecast. Decide if the planned cruise can be made safely.
- Be sure all required documents are onboard.
- Be sure all necessary safety equipment is onboard and operative. This should include items like the running lights, spotlight, life saving devices, fire extinguishers, etc. Refer to the Safety Equipment chapter for additional information on safety equipment.
- Make sure you have signal kits and flare guns aboard, and they are current and in good operating condition.
- Be sure you have sufficient water and other provisions for the planned cruise.
- Leave a written message listing details of your planned cruise with a close friend ashore (Float Plan). The float plan should include a description of your boat, where you intend to cruise, and a schedule of when you expect to arrive in the cruising area and when you expect to return. Keep the person informed of any changes in your plan to prevent false alarms. This information will be useful for authorities so they know where to look and the type of boat to look for in the event you fail to arrive. A float plan form is located in the Appendix section of this manual.
- Check the amount of fuel onboard. Observe the "one third rule" by using: one third of the fuel for the trip out, one third to return and one third in reserve. An additional 15% may be consumed in rough seas.
- Check the water separating fuel filters for water and leaks.
- Check the engine crankcase oil level.
- Turn the battery switches to the ON position.
- Check the bilge water level. Look for other signs of potential problems. Monitor for the scent of fuel fumes.
- Test the automatic and manual bilge pump switches to make sure the system is working properly.



	CAUTION	
THERE MUST BE AT LEAST ONE PERSONAL FLOTATION DEVICE ONBOARD FOR EVERY PERSON ONBOARD AND ONE THROW-OUT FLOTATION DEVICE. CHECK U.S. COAST GUARD STANDARDS FOR THE CORRECT TYPE OF DEVICE FOR YOUR BOAT.		

- Have a tool kit aboard. The kit should include the following basic tools:

Spark plug wrench	Hammer
Spark plug gap gauge	Electrician's tape
Screwdrivers	Offset screwdrivers
Lubricating oil	Pliers
Jackknife	Adjustable wrench
Basic 3/8" ratchet set	Vise grip pliers
Hex key set	Needle nose pliers
Wire crimping tool	End wrench set
Medium slip-joint pliers	Diagonal cutting pliers
DC electrical test light	
- Have the following spare parts onboard:

Extra light bulbs	Spark plugs
Fuses and circuit breakers	Main engine fuses
Assorted stainless screws	Propellers
Assorted stainless bolts	Drain plugs
Flashlight and batteries	Engine oil
Fuel filters	Propeller nuts
Fuel hose and clamps	Wire ties
Wire connector set	Hydraulic steering oil
Assorted hose clamps	Rags
- Make sure all fire extinguishers are in position and in good operating condition.
- Check engine and steering controls for smooth and proper operation. Be sure the shift controls are in the neutral position.
- Be sure the emergency stop lanyard is attached to the operator and the stop switch.
- Refer to the engine owner's manual for pre-operation checks specific to your engines.

2.4 Operating Your Boat

 **WARNING** 

TO REDUCE THE RISK OF A FIRE OR EXPLOSION, DO NOT START THE ENGINES WHEN FUEL FUMES ARE PRESENT. FUEL FUMES ARE DANGEROUS AND HARMFUL TO YOUR HEALTH.

After Starting the Engines

- Visibly check the engines to be sure there are no apparent water, fuel or oil leaks.
- Check the operation of the engine cooling systems.
- Check the engine gauges. Make sure they are reading normally.
- Check the controls and steering for smooth and proper operation.
- Make sure all lines, cables, anchors, etc. for securing a boat are onboard and in good condition. All lines should be coiled, secured and off the decks when underway.
- Have a safe cruise and enjoy yourself.



Remember:

When you operate a boat, you accept the responsibility for the boat, for the safety of passengers and for others out enjoying the water.

- Avoid sea conditions that are beyond the skill and experience of you and your crew.
- Alcohol and any drugs can severely reduce your reaction time and affect your better judgment.
- Alcohol severely reduces the ability to react to several different signals at once.
- Alcohol makes it difficult to correctly judge speed and distance, or track moving objects.
- Alcohol reduces night vision, and the ability to distinguish red from green.

 **WARNING** 



YOU SHOULD NEVER OPERATE YOUR BOAT WHILE UNDER THE INFLUENCE OF ALCOHOL AND DRUGS.

 **WARNING** 

MAKE SURE ONE OTHER PERSON ON THE BOAT IS INSTRUCTED IN THE OPERATION OF THE BOAT AND ALWAYS OPERATE THE BOAT IN COMPLIANCE WITH ALL STATE AND LOCAL LAWS GOVERNING THE USE OF A BOAT.

DO NOT OPERATE THE BOAT UNLESS IT IS COMPLETELY ASSEMBLED. KEEP ALL FASTENERS TIGHT. KEEP ADJUSTMENTS ACCORDING TO SPECIFICATIONS.

Before operating the boat for the first time, read the engine break-in procedures. The break-in procedures are found in the owner's manual for the engines. The manual is in the literature packet. Correct break-in operation is critical to ensure proper performance and longer engine life.

 **CAUTION** 

FAILURE TO FOLLOW THE BREAK-IN PROCEDURE MAY RESULT IN REDUCED ENGINE LIFE OR EVEN SEVERE ENGINE DAMAGE. MAKE SURE YOU FOLLOW THE BREAK-IN PROCEDURE EXACTLY.

As different types of engines are used to power the boat, have the dealer describe the operating procedures for your boat. For more instructions on "How to Operate the Boat," make sure you read the instructions given to you in the owner's manual for the engines you have selected.

Notice:

For more instructions on safety, equipment and boat handling, enroll in one of the several free boating courses offered. For information on the courses offered in your area, call your local boating authority or visit www.uscgboating.org.

Notice:

If the drive unit hits an underwater object, stop the engines. Inspect the drive unit for damage. If the unit is damaged, contact your dealer for a complete inspection and repair of the unit.

To stop the boat, follow this procedure:

- Bring the throttles back to the idle speed position.
- Move the shifting levers to the neutral position.

Operation

Notice:

If the engines have been run at high speed for a long period of time, allow them to cool down by running the engines at idle speed for 3 to 5 minutes.

- Turn the ignition keys to the OFF position.
- Raise the trim tabs to the full up position.

After Operation

- If operating in saltwater, wash the boat and all equipment with soap and water. Flush the engines using fresh water. Refer to the engine owner's manual for instructions on flushing your outboard engines.
- Check the bilge area for debris and excess water. Remove any debris and pump out excess water as necessary.
- Fill the fuel tank to near full to reduce the potential for condensation accumulation in the tank. Allow enough room in the tank for the fuel to expand without being forced out through the vent.
- Turn off all electrical equipment except the battery charger and automatic bilge pumps.
- If you are going to leave the boat for a long period of time, put the battery main switches in the OFF position and close all seacocks.
- Make sure the boat is securely moored.



CAUTION



TO PREVENT DAMAGE TO THE BOAT, CLOSE ALL SEACOCKS BEFORE LEAVING THE BOAT.

2.5 Docking, Anchoring & Mooring Docking and Dock Lines

Maneuvering the boat near the dock and securing the boat require skill and techniques that are unique to the water, wind conditions and the layout of the dock. If possible, position a crew member at the bow and stern to man the lines and assist in docking operations. While maneuvering close to the dock consideration must be given to the wind and current. You should anticipate the effect these forces will have on the boat and use them to help put the boat where you want it. It is important

to practice in open water using an imaginary dock enough to develop a sense for the way your boat handles in a variety of docking scenarios. You must be able to foresee the possibilities and have solutions in mind before problems occur.

Approaching a dock or backing into a slip in high winds or strong currents requires a considerable amount of skill. If you are new to boat handling, you should take lessons from an experienced pilot to learn how to maneuver your boat in tight quarters in less than ideal conditions. You should also practice away from the dock during windy conditions.

Dock lines are generally twisted or braided nylon. Nylon is strong and stretches to absorb shock. It also has a long life and is soft and easy on the hands. The line's size will vary with the size of the boat. Typically a 30 to 40 foot boat will use 5/8-inch line and a 20 to 30 foot boat will use 1/2-inch line. The number of lines and their configuration will vary depending on the dock, the range of the tide, and many other factors. Usually a combination of bow, stern and spring lines are used to secure the boat.

Maneuvering - Twin Engine Boats

If your boat is equipped with a joystick integrated into the engine control system and you are using the joystick to maneuver the boat, you should leave all engines running while using the joystick to maneuver the boat to the dock or back into the slip.

Note that most joystick controls will be deactivated if either throttle & shift control lever is moved while maneuvering the boat.

Electronic control system and joystick operation is unique to the engines installed on your boat. Operation manuals for the engines and control systems are included with this manual. You should read these manuals thoroughly and understand the control system in theory and operation before operating your boat. Additionally, your dealer should demonstrate the operation of the control system and instruct you in operating the controls properly.

Maneuvering to the Dock

Approach the dock slowly at a 30 to 40 degree angle. Whenever possible, approach against the wind or current. Turn the engines straight & shift to neutral when you feel you have enough momentum to reach the dock. Use reverse on the outboard engine while turning the steering wheel towards the dock to slow the boat and pull the stern toward the dock as the boat approaches. Straighten the engines and use both engines to stop the boat if it is still moving forward against the pilings. If you executed your approach properly, the boat will lightly touch the pilings at the same time the forward momentum is stopped. Have the dock lines ready and secure the boat as soon as it stops. Use fenders to protect the boat while it is docked. Keep the engines running until all of the lines are secured.

Backing into a Slip

Approach the slip with the stern against the wind or current and the engines straight ahead. Use the engines and turn the steering wheel to maneuver the boat into alignment with the slip. Reverse the engines and slowly back into the slip. Shift from reverse to neutral frequently to prevent the boat from gaining too much speed. Move the stern right and left by shifting the engines in and out of gear or turning the wheel. When nearly in the slip all the way, straighten the engines and shift to forward to stop. Keep the engines running until the lines are secured.

Securing Dock Lines

Securing a boat that is tied alongside the dock typically requires a bow and stern line and two spring lines. The bow and stern lines are usually secured to the dock at a 40° angle aft of the stern cleat and forward of the bow cleat. The after bow spring line is secured to the dock at a 40° angle aft of the after bow spring cleat. The forward quarter spring is secured to the dock at a 40° angle forward of the stern cleat. The spring lines keep the boat square to the dock and reduce fore and aft movement while allowing the boat to move up and down with the tide.

Securing a boat in a slip is somewhat different. It typically requires two bow lines secured to pilings on each side of the bow, two stern lines secured to the dock and two spring lines that prevent the boat from hitting the dock. The bow lines are typically secured with enough slack to allow the boat to ride the tide. The stern lines are crossed. One line runs from the port aft boat cleat to the starboard dock cleat and the other line runs from

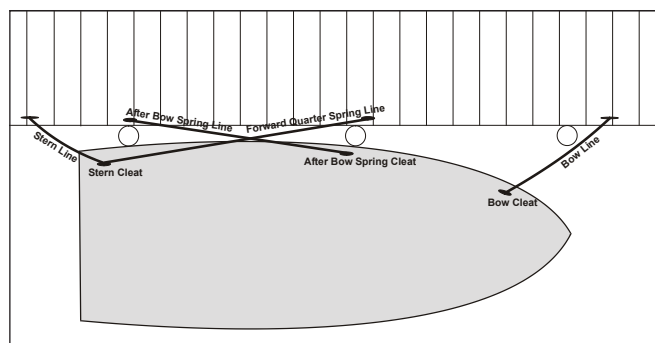

Securing The Boat Along Side A Dock (Typical)

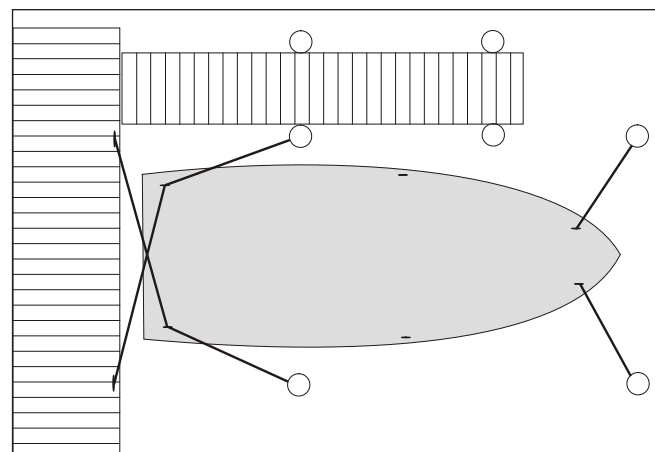

Securing The Boat In A Slip (Typical)

the starboard aft boat cleat to the port cleat on the dock. The stern lines center the boat, control the forward motion, and allow the boat to ride the tide. Two forward quarter spring lines typically are secured to the stern cleats and to mid ship pilings or cleats. The spring lines keep the boat from backing into the dock while allowing it to ride the tide.

Leaving the Dock

Always start the engines and let them warm up for several minutes before releasing the lines. Boats steer from the stern and it is important that you achieve enough clearance at the stern to maneuver the boat as quickly as possible. Push the stern off and maneuver such that you get stern clearance quickly. Proceed slowly until well clear of the dock and other boats.

Operation

Mooring

Approach the mooring heading into the wind or current. Shift to neutral when you have just enough headway to reach the buoy. Position a crew member on the bow to retrieve the mooring with a boat hook and secure the line. Keep the engines running until the line is secured.

Leaving a Mooring

Start the engines and let them warm up for several minutes before releasing the mooring line. The boat will already be headed into the wind, so move it forward enough to loosen the line and untie it. Back the boat away from the mooring until you can see the buoy. Move the boat slowly away from the mooring.

Anchoring

Make sure the bitter end of the anchor line is attached to the boat before dropping the anchor. Bring the bow into the wind or current and put the engines in neutral. When the vessel comes to a stop, lower the anchor over the bow. Pay out anchor line so that it is at least 5 to 7 times the depth of the water and secure the line to a cleat. Use caution to avoid getting your feet or hands tangled in the line. Additional scope of 10 times the depth may be required for storm conditions. Check landmarks on shore or your GPS position to make sure the anchor is not dragging. If it is dragging, you will have to start all over. It is prudent to use two anchors if you are anchoring overnight or in rough weather.

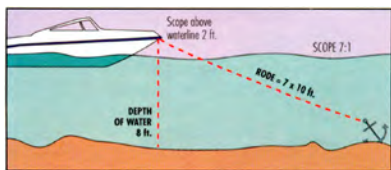

Releasing the Anchor

Release the anchor by driving the boat slowly to the point where the anchor line becomes vertical. It should release when you pass that point. If the anchor doesn't release right away, stop the boat directly above the anchor and tie the line to the cleat as tight as possible. The up and down movement of the boat will usually loosen the anchor within a minute. Make sure you secure the anchor and properly stow the line before operating the boat.



WARNING



NEVER ANCHOR THE BOAT BY THE STERN. THE STERN OF THE BOAT IS VULNERABLE TO SWAMPING FROM WAVE ACTION AND WIND AND CURRENT WILL PUT MORE STRESS ON THE ANCHOR WHEN IT IS ATTACHED TO THE STERN. ONLY ANCHOR THE BOAT BY THE BOW

2.6 Controls, Steering, or Propulsion System Failure

If the propulsion, control or steering system fails while you are operating the boat, bring the throttles to idle and shift to neutral. Decide whether you need to put out the anchor to prevent the boat from drifting or to hold the bow into the seas. Investigate and correct the problem if you can. Turn the engine off before opening the engine cowling to make repairs. If you are unable to correct the problem, call for help.

If only one engine has failed, you can usually run home on the other engine. Be careful not to apply too much power to the engine that is running. When only one engine is used to power a twin engine boat, that engine is over propped and can be overloaded if too much throttle is applied. You should contact your dealer or the engine manufacturer for the maximum power settings when running without one engine.

2.7 Collision

If your boat is involved in a collision with another boat, dock, piling or a sandbar, your first priority is to check your passengers for injuries and administer first aid if necessary. Once your passenger's situations are stabilized, thoroughly inspect the boat for damage. Check below decks for leaks and the control systems for proper operation. Plug all leaks or make the necessary repairs to the control systems before proceeding slowly and carefully to port. Request assistance if necessary. Haul the boat and make a thorough inspection of the hull and running gear for damage.

2.8 Grounding, Towing & Rendering Assistance

The law requires the owner or operator of a vessel to render assistance to any individual or vessel in distress, as long as his vessel is not endangered in the process.

If the boat should become disabled, or if another craft that is disabled requires assistance, great care must be taken. The stress applied to a boat during towing may become excessive. Excessive stress can damage the structure of the boat and create a safety hazard for those aboard.

Freeing a grounded vessel or towing a boat that is disabled requires specialized equipment and knowledge. Line failure and structural damage caused by improper towing have resulted in fatal injuries. Because of this, we strongly suggest that these activities be left to those who have the equipment and knowledge, e.g., the U.S. Coast Guard or a commercial towing company, to safely accomplish the towing task.

DANGER

THE MOORING CLEATS ON CREVALLE BOATS ARE NOT DESIGNED OR INTENDED TO BE USED FOR TOWING PURPOSES. THESE CLEATS ARE SPECIFICALLY DESIGNED AS MOORING CLEATS FOR SECURING THE BOAT TO A DOCK, PIER, ETC. DO NOT USE THESE FITTINGS FOR TOWING OR ATTEMPTING TO FREE A GROUNDED VESSEL.

WHEN TOWING OPERATIONS ARE UNDERWAY, HAVE EVERYONE ABOARD BOTH VESSELS STAY CLEAR OF THE TOW LINE AND SURROUNDING AREA. A TOW LINE THAT SHOULD BREAK WHILE UNDER STRESS CAN BE VERY DANGEROUS, AND COULD CAUSE SERIOUS INJURY OR DEATH.

WARNING

RUNNING AGROUND CAN CAUSE SERIOUS INJURY TO PASSENGERS AND DAMAGE TO A BOAT AND ITS UNDERWATER GEAR. IF YOUR BOAT SHOULD BECOME GROUNDED, DISTRIBUTE PERSONAL FLOTATION DEVICES AND INSPECT THE BOAT FOR POSSIBLE DAMAGE. THOROUGHLY INSPECT THE BILGE AREA FOR SIGNS OF LEAKAGE. AN EXPERIENCED SERVICE FACILITY SHOULD CHECK YOUR UNDERWATER GEAR AT THE FIRST OPPORTUNITY. DO NOT CONTINUE TO USE YOUR BOAT IF THE CONDITION OF THE UNDERWATER EQUIPMENT IS QUESTIONABLE.

2.9 Flooding or Capsizing

Boats can become unstable if they become flooded or completely swamped. You must always be aware of the position of the boat to the seas and the amount of water in the bilge. Water entering the boat over the transom can usually be corrected by turning the boat into the waves. If the bilge is flooding because of a hole in the hull or a defective hose, you may be able to plug it with rags, close the thru-hull valve or assist the bilge pumps by bailing with buckets. Put a mayday call in to the Coast Guard or nearby boats and distribute life jackets as soon as you discover your boat is in trouble.

If the boat becomes swamped and capsizes, you and your passengers should stay with the boat as long as you can. It is much easier for the Coast Guard, aircraft, or other boats to spot the boat, than just people in the water.

2.10 Fishing

Fishing can be very exciting and distracting for the operator when the action gets intense. You must always be conscious of the fact that your primary responsibility is the safe operation of your boat and the safety of your passengers and other boats in the area.



You must always make sure the helm is properly manned and is never left unattended while trolling. If you are fishing in an area that is crowded with other fishing boats, it may be difficult to follow the rules of the road. This situation can become especially difficult when most boats are trolling. Being courteous and exercising good common sense is essential. Avoid trying to assert your right of way and concentrate on staying clear and preventing tangled or cut lines and other unpleasant encounters with other boats. Also keep in mind that fishing line wrapped around a propeller shaft can damage seals in the engine's lower unit. If fishing line becomes tangled in the propeller shaft, remove it as soon as possible and have your authorized engine dealer check the propeller shaft seals for damage and leakage.

Operation

2.11 Man Overboard

If someone falls overboard, you must be prepared to react quickly, particularly when you are offshore. The following procedures will help you in recovering a person that has fallen overboard.

- Immediately stop the boat and sound a man overboard alarm and have all passengers point to the person in the water.
- Circle around quickly and throw a cushion or life jacket to the person, if possible, and another to use as a marker.
- Keep the person on the driver side of the boat so you can keep him in sight at all times.
- Make sure to approach the person from the downwind side and maneuver the boat so the propellers are well clear of the person in the water.
- Turn off the engines when the person is alongside and use a ring buoy or a boat cushion with a line attached, a paddle or boathook to assist him to the boat. Make sure you don't hit him with the ring buoy or the boat.
- Pull the person to the boat and assist him onboard.
- Check the person for injuries and administer first aid if necessary. If the injuries are serious, call for help. Refer to the Safety Equipment chapter for more information on first aid and requesting emergency medical assistance.

 **WARNING** 

MOVING PROPELLERS ARE DANGEROUS. THEY CAN CAUSE DEATH, LOSS OF LIMBS, OR OTHER SEVERE INJURY. DO NOT USE THE SWIM PLATFORM OR SWIM LADDER WHILE THE ENGINES ARE RUNNING. STOP THE ENGINES IF DIVERS OR SWIMMERS ARE ATTEMPTING TO BOARD. ALWAYS PROPERLY STORE THE LADDER BEFORE STARTING THE ENGINES.

2.12 Water Skiing & Wakeboarding

Your boat could be equipped for water skiing and wakeboarding. If you have never driven skiers before, you should spend some hours as an observer and learning from an experienced driver. If you are an experienced driver, you should take some time to become familiar with the boat and the way it handles before pulling a skier. The

driver should also know the skier's ability and drive accordingly.

The following safety precautions should be observed while towing water skiers.

- Water ski only in safe areas, away from other boats and swimmers, out of channels and in water free of underwater obstructions. The area should be at least 5 feet deep, 3000 feet long and have at least 100' between each side of the boat and any obstructions.
- Make sure that anyone who skis can swim. Do not allow people who cannot swim to water ski.
- Be sure that the skier is wearing a proper life jacket. A water skier is considered onboard the boat and a Coast Guard approved life jacket is required. It is advisable and recommended for a skier to wear a flotation device designed to withstand the impact of hitting the water at high speed.
- Make sure to inspect the ski equipment and tow rope before each ski session. Never use equipment that is damaged or with loose screws, torn boots, severe corrosion or tears in the fabric. You should also inspect the ski tow rope and replace if it is frayed, has unnecessary knots or is damaged. Never use a ski tow line that is questionable.
- Secure the ski tow rope to an appropriate device intended for ski tow ropes.
- Always carry a second person onboard to observe the skier or wakeboarder so that your full attention can be given to the safe operation of the boat. The operator should pay attention to driving the boat and have the observer keep him updated on the skier. Never ski after dark. It is hazardous and illegal. Neither the boat operator or skier can see well enough to navigate at skiing or wakeboarding speeds safely at night.
- Never spray swimmers, boats, rafts or other skiers. The risk for a collision makes this dangerous for the skier and people being sprayed.
- Never follow directly behind another boat while pulling skiers. Always stay a safe distance behind or off the side of other boat traffic. If the boat you are following stops unexpectedly, you may not be able to respond quick enough endangering your skier and occupants of both boats.

- Never follow behind another boat pulling a skier for any reason, even if you are not pulling a skier. If the skier you are following falls, you may not be able to respond quick enough and could run over the skier.
- When pulling multiple skiers, make sure the ropes are the same length. Never pull multiple skiers with tow ropes of different lengths.
- Always make sure to slowly pull the slack out of the ski rope and wait for the OK from the skier before advancing the throttle to ensure the rope is not wrapped around the skier and that the skier is ready. Never advance the throttle until the skier provides the ready signal.
- When turning around to pick up a fallen skier, make sure to look for other boat traffic in the direction of the turn before you turn the boat.
- Approach a skier in the water from the downwind side and be certain to stop the motion of the boat and your motor before coming in close proximity to the skier.
- Give immediate attention to a fallen skier. A fallen skier is very hard to see by other boats and is extremely vulnerable. When a skier falls, be prepared to immediately turn the boat and return to the skier.
- Never leave a fallen skier alone in the water for any reason and have an observer display a skier down flag to alert other boaters that your skier has fallen.
- Agree on hand signals to be used between the observer and skier to communicate. This is important to eliminate confusion and ensure the safety of your skiers, wakeboarders or tubers. Refer the Hand Signals drawing in this section for signals that are commonly used during water sports activities.
- Make sure the observer watches for the skier's signal to indicate he or she is OK. If the signal is not seen immediately, assume the skier is injured and in need of immediate assistance. Be prepared to respond quickly.

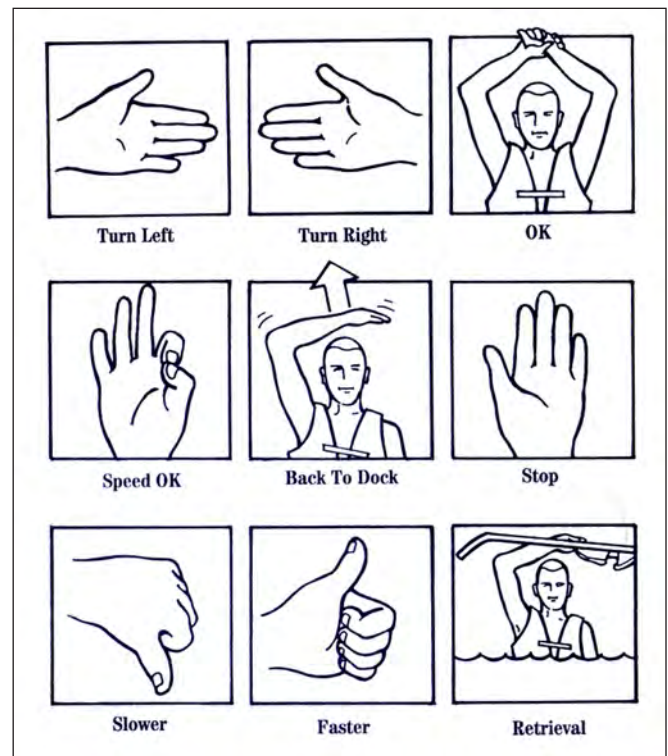

Common Hand Signals for Water Sports Activities

- For additional information on water skiing, including hand signals and water skiing manuals, contact the American Water Skiing Association in Winter Haven, Florida, 813-324-4341.



WARNING



MOVING PROPELLERS ARE DANGEROUS. THEY CAN CAUSE DEATH, LOSS OF LIMBS OR OTHER SEVERE INJURY. DO NOT USE THE SWIM PLATFORM OR SWIM LADDER WHILE THE ENGINE IS RUNNING. STOP THE ENGINE IF DIVERS, SWIMMERS OR SKIERS ARE ATTEMPTING TO BOARD. ALWAYS PROPERLY STORE THE LADDER BEFORE STARTING THE ENGINE.

Operation

2.13 Trash Disposal

The discharge of plastic trash or trash mixed with plastic is illegal anywhere in the marine environment. U.S. Coast Guard regulations also restrict the dumping of other forms of garbage. Regional, state and local restrictions on garbage discharges also may apply.

Responsible boaters store refuse in bags and dispose of it properly on shore. You should make sure your passengers are aware of the local waste laws and the trash management procedure on your boat. Refer to the placard mounted on your boat for more specific information regarding solid waste disposal.

Federal law requires that vessels of 26 feet or longer must display in a prominent location, a durable placard at least 4 by 9 inches notifying the crew and passengers of the discharge restrictions (Marpol Treaty). A label for this purpose has been shipped with the boat and is attached to the side of the cockpit or a cockpit hatch. It is the boat owner's responsibility to make sure this placard remains mounted and legible in accordance with the law.





2.14 Yacht Certification Plate

Coast Guard rules require boats less than 20 feet (6 meters) to display a gross weight and person-capacity plate provided by the manufacturer.

Boat manufacturers in the National Marine Manufacturers Association (NMMA) program will display a gross weight and person-capacity plate on boats up to 26 feet (7.9 meters). Larger boats, including your boat, will display a Yacht Certification plate indicating compliance with the NMMA and U.S. Coast Guard requirements instead of a capacity plate.

The yacht certification plate is usually located near the helm in clear view of the operator.

It is illegal for any vessel to dump plastic trash ANYWHERE in the ocean or navigable waters of the United States. Annex V of the MARPOL TREATY is an International Law for a cleaner, safer marine environment. Violation of these requirements is a Class D felony and may result in civil penalty up to a \$25,000 fine and imprisonment.

 U.S. Lakes, Rivers, Bays sounds and 3 miles from shore ILLEGAL TO DUMP Plastic & Garbage Paper Metal Rags Crockery Glass Dunnage Food	 3 to 12 miles ILLEGAL TO DUMP Plastic Dunnage, lining & packing materials that float, also if not ground to less than one inch Paper Crockery Rags Metal Glass Food	 12 to 25 miles ILLEGAL TO DUMP Plastic Dunnage, lining & packing materials that float	 Outside 25 miles ILLEGAL TO DUMP Plastic
-------------------------------------------------------------------------------------------------------------------------------------------------------------------------------------------------------------------------------------------------------	-------------------------------------------------------------------------------------------------------------------------------------------------------------------------------------------------------------------------------------------------------------------------------------	----------------------------------------------------------------------------------------------------------------------------------------------------------------------------------------------	------------------------------------------------------------------------------------------------------------------------------------------------

Regional state and local regulations may further restrict the disposal of garbage. The discharge of all garbage into the Great Lakes or their connecting or tributary waters is prohibited.



Trash Disposal & Discharge of Placards on Starboard Side of Cockpit

2.15 Trailering Your Boat

If you trailer your boat, make sure that your tow vehicle is capable of towing the weight of the trailer, boat and equipment and the weight of the passengers and equipment inside the vehicle. This may require that the tow vehicle be specially equipped with a larger engine, transmission, brakes and trailer tow package. Additionally, the laws in your state may require special permits to tow a boat this large on some or all highways.

The boat trailer is an important part of your boating package. The trailer should be matched to your boat's weight and hull. Using a trailer with a capacity too low will be unsafe on the road and cause abnormal wear. A trailer with a capacity too high, can damage the boat. Contact your trailer dealer to evaluate your towing vehicle and hitch and to make sure you have the correct trailer for your boat.

Important:

Your Crevalle is a heavy boat and care must be taken when selecting the trailer. We recommend that you use a bunk style trailer that incorporates a combination of heavy duty rollers or bunks, to support the keel and long bunks running under and parallel to the stringers to support the hull. Avoid using a full roller trailer that does not have bunks. Roller trailers have a tendency to put extreme pressure points on the hull, especially on the lifting strakes and have damaged boats. The situation is worse during launching and haul out. Damage resulting from improper trailer support or the use of a full roller trailer will not be covered by the Crevalle Warranty.

Notice:

Contact your trailer dealer to evaluate your towing vehicle and hitch and to make sure you have the correct trailer for your boat.

- Make sure the trailer is a match for your boat's weight and hull design. More damage can be done to a boat by the stresses of road travel than by normal water operation. A boat hull is designed to be supported evenly by water. So, when it is transported on a trailer it should be supported structurally as evenly across the hull as possible allowing for even distribution of the weight of the hull, engines and equipment.

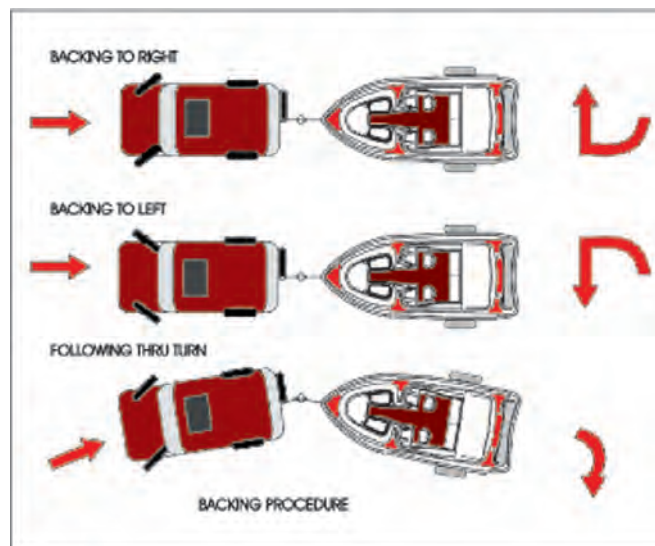

Backing Procedure for Boat Trailers

- Make sure the trailer bunks and/or rollers properly support the hull and do not put pressure on the lifting strakes. The rollers and bunks must be kept in good condition to prevent scratching and gouging of the hull.
- The capacity rating of the trailer should be greater than the combined weight of the boat, motor and equipment. The gross vehicle weight rating must be shown on the trailer. Make sure the weight of the boat, engine, gear and trailer is not more than the gross vehicle weight rating.
- Make sure the boat is securely fastened on the trailer to prevent movement between the boat and trailer. The bow eye on the boat should be secured with a rope, chain or turnbuckle in addition to the winch cable. Additional straps may be required across the beam of the boat or from the transom eyes to the trailer.

Notice:

Your trailer dealer will give instructions on how to load, fasten and launch your boat.

⚠
CAUTION
⚠

BOATS HAVE BEEN DAMAGED BY TRAILERS THAT DO NOT PROPERLY SUPPORT THE HULL. ALWAYS MAKE SURE THE TRAILER BUNKS AND ROLLERS ARE ADJUSTED SO THEY ARE NOT PUTTING EXCESSIVE PRESSURE ON THE LIFTING STRAKES AND ARE PROVIDING ENOUGH SUPPORT FOR THE HULL. HULL DAMAGE RESULTING FROM IMPROPER TRAILER SUPPORT IS NOT COVERED BY THE CREVALLE WARRANTY.

Operation

Before Going Out On The Highway:

- Side curtains, clear connector, backdrop and aft curtain must be removed when trailering. Canvas enclosures are not designed to withstand the extreme wind pressure encountered while trailering and will be damaged. Always remove and properly store the enclosure before trailering your boat.
- Make sure the tow BALL and TRAILER COUPLER are the same size and bolts and nuts are tightly secured.
- The COUPLER MUST BE COMPLETELY OVER THE BALL and the LATCHING MECHANISM LOCKED DOWN.
- Make sure the TRAILER IS LOADED EVENLY from front to rear as well as side to side and has the correct weight on the hitch. Too much weight on the hitch will cause the rear of the tow vehicle to drag and may make steering more difficult. Too little weight on the hitch will cause the rig to fishtail and will make controlling the tow vehicle difficult. Contact your trailer manufacturer or dealer for the correct weight on the hitch for your trailer.
- The SAFETY CHAINS must be attached crisscrossing under the coupler to the frame of the tow vehicle. If the ball was to break, the trailer would follow in a straight line and prevent the coupler from dragging on the road. Make sure the trailer emergency brake cable or chain is also installed to the tow vehicle frame.
- Make sure the LIGHTS on the trailer function properly.
- CHECK THE BRAKES. On a level parking area roll forward and apply the brakes several times at increasing speeds to determine if the brakes on the tow vehicle and trailer are working properly.
- Make sure the tow vehicle has SIDE VIEW MIRRORS that are large enough to provide an unobstructed rear view on both sides of the vehicle.
- CHECK THE TIRES and WHEEL BEARINGS.

Notice:

Make sure your towing vehicle and trailer are in compliance with all state and local laws. Contact your state motor vehicle bureau for laws governing the towing of trailers.

3.1 General

Your boat is designed to be powered with two 4-cycle outboard motors. 4-cycle outboard engines do not use an oil injection system and are not equipped with an oil tank. They have an oil sump in the crankcase that must be kept full of the type of oil recommended by the engine manufacturer. Engine oil must be checked before each use and changed regularly.

Each outboard motor manufacturer provides an owner's manual with its product. It is important that you read the manual(s) very carefully and become familiar with the proper care and operation of the engines and drive systems. A warranty registration card has been furnished with each new engine and can be located in the engine owner's manual. All information requested on this card should be filled out completely by the dealer and purchaser and returned to the respective engine manufacturer as soon as possible.



Outboard Power System



WARNING



DO NOT ATTEMPT TO SERVICE ANY ENGINE OR DRIVE COMPONENT WITHOUT BEING TOTALLY FAMILIAR WITH THE SAFE AND PROPER SERVICE PROCEDURES. CERTAIN MOVING PARTS ARE EXPOSED AND CAN BE DANGEROUS TO SOMEONE UNFAMILIAR WITH THE OPERATION AND FUNCTION OF THE EQUIPMENT.



WARNING



DO NOT INHALE EXHAUST FUMES! EXHAUST CONTAINS CARBON MONOXIDE THAT IS COLORLESS AND ODORLESS. CARBON MONOXIDE IS A DANGEROUS GAS THAT IS POTENTIALLY LETHAL.

3.2 Drive System Corrosion

Each outboard motor is a complete drive system with the gear case being just forward of the propeller and connected to the power head with a vertical drive shaft. All engines require some maintenance. Routine maintenance recommended for your engine is outlined in the engine owner's manual. Routine maintenance is normally the primary concern unless the boat is to be kept in saltwater for extended periods of time. Then

the main concerns are marine growth and galvanic corrosion.

Marine growth occurs when components are left in the water for extended periods and can cause poor performance or permanent damage to the exposed components. The type of growth and how quickly it occurs is relative to the water conditions in your boating area. Water temperature, pollution, current, etc. can have an effect on marine growth.

Galvanic corrosion is the corrosion process occurring when different metals are submerged in an electrolyte. Seawater is an electrolyte and submerged engine components must be properly protected. Outboard motors are equipped with sacrificial anodes to prevent galvanic corrosion problems. The anodes must be monitored and replaced as necessary. For locations and maintenance, please refer to the engine owner's manual.

When leaving the boat in the water, tilt the motors as high as possible. This will decrease the risk of marine growth around the cooling inlets, propeller and exhaust ports or damage from galvanic corrosion.

Propulsion System



CAUTION



DO NOT PAINT OUTBOARD MOTORS WITH ANTIFOULING PAINTS DESIGNED FOR BOAT HULLS. MANY OF THESE PAINTS CAN CAUSE SEVERE DAMAGE TO THE ENGINES. CONTACT YOUR DEALER OR ENGINE MANUFACTURER FOR INFORMATION ON THE PROPER PAINTING PROCEDURES.

3.3 Engine Lubrication

4-cycle outboard engines incorporate a pressure-type lubrication system with an oil sump in the crankcase that must be kept full of the type and grade of oil recommended by the engine manufacturer. It is normal for 4-cycle engines to consume a small amount of oil. Therefore, the oil must be checked before each use and changed at regular intervals as instructed by the engine owner's manual.

Notice:

Always monitor the oil level in the crankcase and only use the type of oil specified by the engine manufacturer.

3.4 Engine Cooling System

Outboard engines are raw water (seawater) cooled. Water is pumped through the water inlets, circulated through the engine block, and relinquished with the exhaust gases through the propeller hub. The water pump uses a small impeller made of synthetic rubber. The impeller and water pump cannot run dry for more than a few seconds. In most outboard motors, some cooling water is diverted through ports below the engine cowling. This allows the operator to visually check the operation of the cooling system. When the engine is started, always check for a steady stream of water coming out of those ports.

Notice:

If the boat is used in salt or badly polluted water, the engines should be flushed after each use. Refer to the engine owner's manual for the proper engine flushing procedure.



CAUTION



NEVER RUN AN OUTBOARD MOTOR WITHOUT WATER FLOWING TO THE WATER PUMP. SERIOUS DAMAGE TO THE WATER PUMP IMPELLER OR ENGINE COULD RESULT.

3.5 Propellers

The propellers convert the engine's power into thrust. They come in a variety of styles, diameters and pitches. The propellers that will best suit the needs of your boat will depend somewhat on your application and expected average load. Propeller sizes are identified by two numbers stamped on the prop in sequence. The 1st number in the sequence (example 14" x 21") is the diameter of the propeller, and the 2nd number is the pitch. Pitch is the theoretical distance traveled by the propeller in one revolution.

Always repair or replace a propeller immediately if it has been damaged. A damaged and therefore out of balance propeller can cause vibration that can be felt in the boat and could damage the engine gear assembly. Refer to the engine owner's manual for information on propeller removal and installation.

3.6 Performance Issues & Propellers

It is extremely important that the boat is propped to run at or very near the recommended top RPM with an average load. If the top RPM is above or below the recommend range, the propellers must be changed to prevent loss of performance and possible engine damage.

Twin engine boats are equipped from the factory with counter rotating engines that are mounted to achieve quicker planing and optimum performance. Therefore, the left hand rotation engine is mounted on the port side of the transom and the right hand rotation engine is mounted on the starboard side. You should make sure that each propeller matches the rotation of the engine.

Notice:

Before changing propellers to correct boat performance problems, be sure factors such as engine tuning, bottom and running gear growth, etc. are not the source of performance changes. Always be sure the load conditions are those normally experienced, before changing propellers.

Your boat was shipped with propellers that typically provide optimum performance for your boat. However there are factors that can affect performance and propeller requirements.

The following are some other factors to consider:

- You should be sure the load conditions are those normally experienced. If the boat ran in the required RPM range when it was new and you have not added any additional gear or heavy equipment and have not damaged the propellers, there is a good chance the propellers are not the problem.
- The addition of heavy equipment such as a tower, life rafts, additional coolers, etc., will cause additional load on the engines. Consequently, different propellers may be required.
- Boats operated at high altitudes (above 2000 feet). Engines operated at high altitudes will not be able to develop as much horsepower as they do at or near sea level. Consequently, different propellers may be required.

Notice:

Outboard engines can be damaged and the warranty void if the boat is not propped correctly. Always consult your dealer or authorized engine service dealer when making changes to the propellers or if the boat does not run near the top recommended RPM.



Typical Yamaha Propeller

Propulsion System

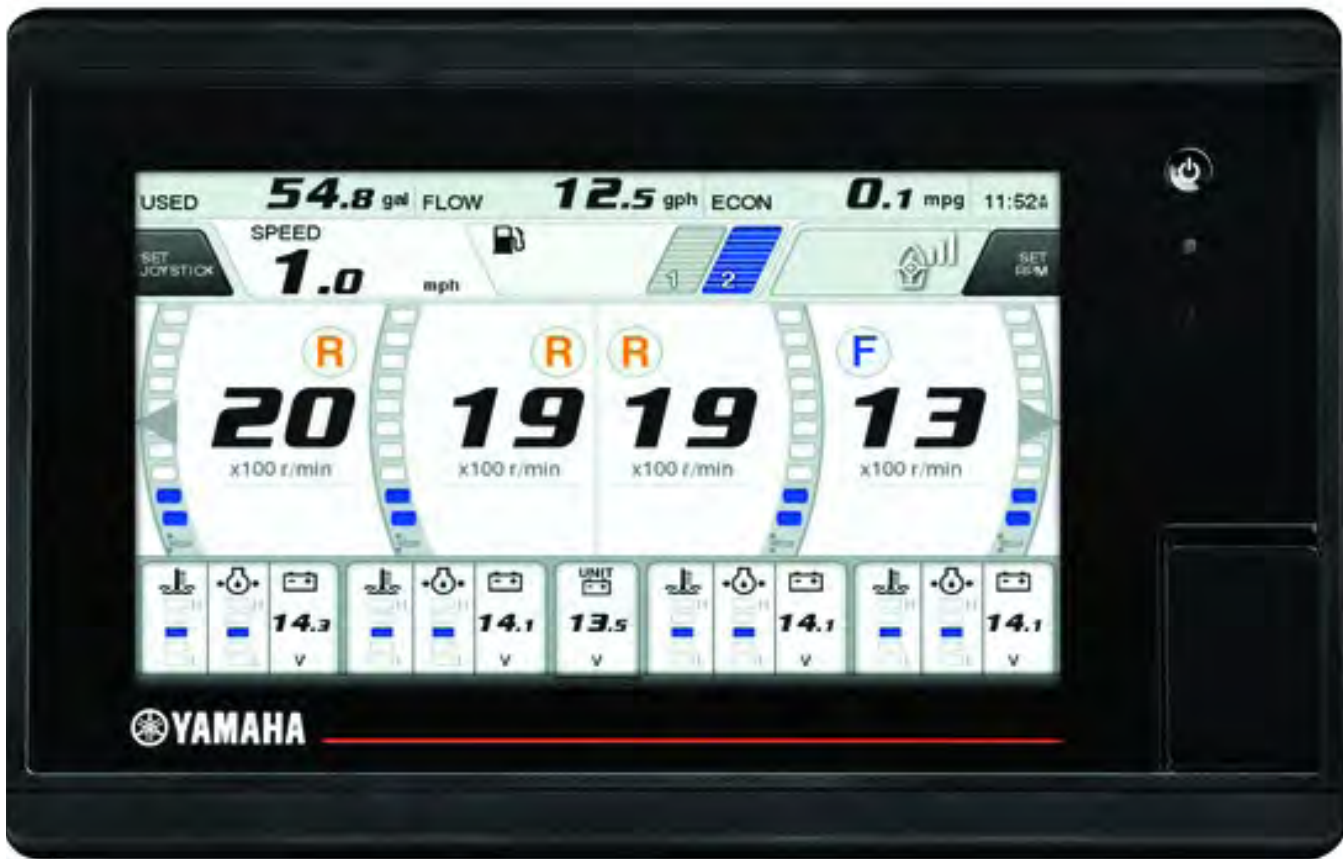

Typical Yamaha Twin Engine Display

3.7 Engine Instrumentation

The helm station is equipped with a set of engine instruments and/or alarms. These instruments allow the operator to monitor the operational condition of the engines. Close observation of these instruments allows the operator to operate the engines at the most efficient level and could save them from serious costly damage.

Most Crevale boats are equipped with Yamaha engines and a Command Link® Plus LCD multifunction display or Mercury engines with a VesselView 4 display. These systems can be integrated with the optional electronic navigation equipment installed on your boat.

A brief description of the gauges and their basic functions integrated in these display systems are listed in this section. Other functions that are dependent on the electronics installed on your boat may be available. Refer to the engine and display system owner's manuals and the manuals for the electronics installed on your boat for detailed information on the operation of the instruments and additional functions available.

Remember, the instrumentation is unique to the type of outboard motors installed on your Crevale.

Some or all of the following gauges may be present.

Tachometer

The tachometers display the speed of the engines in revolutions per minute (RPM). This speed is not the boat speed or necessarily the speed of the propeller.

CAUTION

NEVER EXCEED THE MAXIMUM RECOMMENDED OPERATION RPM OF THE ENGINES. MAINTAINING MAXIMUM OR CLOSE TO MAXIMUM RPM FOR EXTENDED PERIODS CAN REDUCE THE LIFE OF THE ENGINES.

Speedometer

Speedometers can indicate boat speed via the engine pickup or an optional GPS or depth sounder triducer, if these options are installed in your boat. Refer to the engine display and electronics operating manuals for more information on the speedometer options available for your boat.

Temperature Gauge

The temperature gauge indicates the temperature of the engine cooling system. A sudden increase in the temperature could signal a blocked cooling passage or a water pump malfunction.

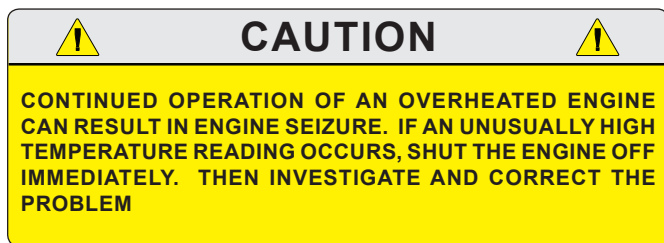

Oil Pressure Gauge

The oil pressure gauge monitors the engine lubrication system pressure. The oil pressure indicated when the engine is new is usually the reference for normal oil pressure for that engine. A drop in oil pressure is a possible indication of oil pump problems, a leak or fuel diluted oil.

Fuel Gauge

The fuel gauge indicates the amount of fuel in the fuel tank. This gauge is merely a relative indication of the available fuel supply and not a calibrated instrument.

Voltmeter

The voltmeter displays the voltage for the battery and the charging system. The normal voltage is 11 to 12.5 volts with the engines off, and 13 to 14.5 volts with the engines running.

Hour Meter

The hour meter keeps a record of the operating time for each engine.

Tilt/Trim Gauge

The tilt/trim gauge monitors the position of the engines. The upper range of the gauge indicates the tilt, which is used for trailering and shallow water operation. The lower range indicates the trim position. This is the range used to adjust the hull angle while operating your boat on plane.

Refer to the Helm Control Systems chapter and the engine owner's manual for more information on the operation of the power tilt and trim.



Mercury VesselView 403
Tachometer & Engine Monitoring Display

Depth Gauge

The Depth gauge indicates the depth of the water below the bottom of the boat. The gauge is equipped with a shallow water alarm. The alarm will sound at a depth preset by the operator.

Fuel Management

Fuel management systems could be installed on your boat as part of the engine monitoring system. On most engines, the fuel management gauge is built into the digital display and can monitor miles per gallon, total gallons used and total gallons remaining.

If you have a fuel management system installed on your boat, refer to the engine or fuel management manual for information on that system.

Engine Alarm

Outboard engines are equipped with an audible alarm system mounted in the helm area that monitors selected critical engine systems. The alarm will sound if one of these systems begins to fail. Refer to the engine owner's manual for information on the alarms installed with your engine.

If an engine alarm sounds, immediately shut off the engine, if safe to do so, until the problem is found and corrected.

Propulsion System

Depth Gauge (Optional)

The depth gauge indicates the depth of the water below the bottom of the boat.

Compass

All boats are equipped with a compass on the top of the instrument panel. The compass cannot be adjusted accurately at the factory as it must be compensated for the influence of the electrical equipment and electronics unique to your boat. Therefore, the compass should be adjusted by a professional after the electronics and additional electrical accessories are installed and before operating the boat. To adjust the compass for your area, read the instructions on "Compass Compensation" given to you in the literature packet.



Compass

Instrument Maintenance

Electrical protection for instruments and ignition circuitry is provided by a set of fuses or circuit breakers located on each engine. The ignition switches should be sprayed periodically with a contact cleaner/lubricant. Ignition switches and all instruments, controls, etc. should be protected from the weather when not in use. Excessive exposure can lead to gauge and ignition switch difficulties.

4.1 General

The helm controls consist of three systems: the engine throttle and shift controls, steering system, and the trim tab control switches. These systems provide the operator with the ability to control the direction and attitude of the boat from the helm station.

Each manufacturer of the control components provides an owner's manual with its product. It is important that you read the manuals and become familiar with the proper care and operation of the control systems.

4.2 Engine Throttle & Shift Controls

The shift and throttle controls on your boat may vary depending on the engine and options selected. The following description is typical of most electronic control systems. Refer to the engine or control manual for specific information on the controls installed on your Boat.

Electronic engine controls are standard on all large outboard engines. The following control description is typical of most electronic control installations.

The helm is designed for a binnacle style control with a single lever for each engine. The electronic control system consists of three major components: the electronic control head, instruments and keypad, control processors and applicable harnesses. The controls are completely electronic and there are no cables.

The control has a single lever for each engine that operates as a gearshift and a throttle. General operation will include a position for neutral (straight up and down or slightly aft of vertical), a forward position (the 1st detent forward of neutral), and a reverse position (the 1st detent aft of neutral). Advancing the control lever beyond the shift range advances the throttle in forward or reverse.

Each control lever is equipped with a means of permitting the engine to be operated at a higher than idle RPM while in neutral for cold starting and warm-up purposes. The levers are also equipped with adjustable detent and friction settings.



Mercury Electronic Controls

Most controls and key pads have integrated switches and indicator lights which allow the operator to control all aspects of the boat's propulsion system. LED lights on the control pad indicate that the control is activated and the engines can be started.

The most common features activated or monitored by the keypad are:

- Starter lockout, which prevents the engine from being started in gear.
- Gear lockout, which allows the engine RPM to be advanced in neutral safely.
- Battery voltage warning indicator that warns the operator of high or low voltage supplied to the system (audible alarm)
- An engine synchronization feature that automatically keeps both engines at the same RPM while cruising. Refer to Engine Synchronizing in this section and the control systems owner's manual for more information regarding engine synchronization.

Helm Control Systems

- Trolling feature that allows the operator to increase the engine speed in 50 RPM increments while operating at trolling speeds between 600 - 1000 RPM.
- Station transfer that allows the operator to transfer control from one station to another with the push of a button on boats with two helm stations. Each station must be selected before the controls will operate from that station.

These features and others not mentioned require specific procedures to activate and operate them properly. Some of the procedures and features are unique to the engines and other options installed on your boat. It is essential that you read the owner's manual for the controls and be completely familiar with their operation before using your boat.

CAUTION

ALWAYS RETURN THE ENGINE THROTTLE LEVER TO THE EXTREME LOW SPEED POSITION BEFORE SHIFTING. NEVER SHIFT THE UNIT WHILE ENGINE SPEED IS ABOVE IDLE RPM.



Yamaha Control Tilt & Trim Switches

Engine Synchronizer

During most operations of a twin engine boat, it is advantageous for both engines to be operated at the same RPM. This reduces noise and vibration and can increase engine efficiency. Setting the throttles so that the engines are running the same RPM (synchronized) can be done by listening to the engine sounds at low RPM and with the automatic synchronizer feature built into the electronic engine controls when the engines are operating above 1000 RPM. Attempting to synchronize the engines solely by using the tachometer readings or control lever placement generally will not work. When the engines are in proper synchronization, the throttle levers may not necessarily be even.

Refer to the engine or control owner's manuals for more information on the engine synchronizer and other features for the electronic controls installed on your boat.

4.3 Neutral Safety Switch

Every control system has a neutral safety switch incorporated into it. This device prohibits an engine from being started while the shift lever is in any position other than the neutral position. If the engine will not start, slight movement of the shift lever may be necessary to locate the neutral position and disengage the safety cutout switch. Control adjustments may be required to correct this condition should it persist. See your Crevalle dealer for necessary control adjustments.

The neutral safety switches should be tested periodically to ensure that they are operating properly. To test the neutral safety switches, make sure the engines are tilted down and move the shift levers to the forward position.

Make sure the throttle control levers are not advanced past the idle position. Press the start button or turn the key just long enough to briefly engage the starter for the engine.

Notice:

Some outboard control systems are equipped with a computer controlled start feature that will keep the starter engaged until the engine starts if the neutral safety switch fails and allows the starter to engage.

The starter should not engage for any engine. Repeat this test with the shift levers in reverse and the engine throttles at idle. Again, the starter should not engage for any engine. If the starter for any engine engages with the shift controls in any position other than the neutral position, then the neutral safety switch is not functioning properly and you should contact your dealer to have the neutral safety switch repaired by a qualified marine mechanic before using the boat. If an engine starts in gear during this test, immediately move the control lever to the neutral position and turn the engine off.



Mercury Control Tilt & Trim Switches



WARNING



IN SOME SITUATIONS, IT MAY BE POSSIBLE TO ACCIDENTALLY START THE ENGINES IN GEAR WITH THE THROTTLES ABOVE IDLE IF THE NEUTRAL SAFETY SWITCH IS NOT OPERATING PROPERLY. THIS WOULD CAUSE THE BOAT TO ACCELERATE UNEXPECTEDLY IN FORWARD OR REVERSE AND COULD RESULT IN LOSS OF CONTROL, DAMAGE TO THE BOAT OR INJURY TO PASSENGERS. ALWAYS TEST THE NEUTRAL SAFETY SWITCH PERIODICALLY AND CORRECT ANY PROBLEMS BEFORE USING THE BOAT.

4.4 Engine Power Tilt & Trim

All outboard engines have a tilt and trim feature. Most outboard engines have tilt/trim switches built into the engine shift and throttle controls that allow the operator to control the position of the outboards from the helm. Typically, a switch or switches on the port control lever grip activates the tilt/trim for the engines. Twin engine controls have two switches on the cover that activate each engine tilt/trim individually. If necessary, the maximum tilt angle can be adjusted by your Crevalle or engine dealer by reprogramming the settings using the engine manufacturer's diagnostic system.

Moving the outboard closer to the boat transom is called trimming "in" or "down." Moving the outboard further away from the boat transom is called trimming "out" or "up." In most cases, the boat will run best with the outboard adjusted so the hull will run at a 3 to 5 degree angle to the water.

The term "trim" generally refers to the adjustment of the outboard within the first 20° range of travel. This is the range used while operating your boat on plane. The term "tilt" is generally used when referring to adjusting the outboard further up for shallow water operation or trailering. For information on the proper use and maintenance of the power tilt and trim, refer to the engine owner's manual.



CAUTION



ENGINE HOSES AND CABLES OR THE TRANSOM GEL COAT CAN BE DAMAGED BY TILTING THE ENGINES TO THE FULL UP POSITION WITH THE ENGINES TURNED TO THE WRONG POSITION. MOST BOATS REQUIRE THE STEERING WHEEL TO BE TURNED COMPLETELY TO STARBOARD BEFORE TILTING THE ENGINES TO THE FULL UP POSITION. YOU SHOULD MONITOR EACH ENGINE AS IT TILTS TO DETERMINE BEST FULL TILT ENGINE POSITION FOR YOUR BOAT.



CAUTION



SOME AUTOPILOTS HAVE ENGINE POSITION SENSORS THAT ARE MOUNTED TO THE HYDRAULIC STEERING CYLINDER. WITH THESE AUTOPILOTS, THE ENGINE POSITION SENSOR BRACKET COULD HIT THE TRANSOM WHEN THE ENGINES ARE TILTED TO THE FULL UP POSITION AND CAUSE DAMAGE TO THE ENGINE RIGGING, THE AUTOPILOT OR THE TRANSOM. IF YOU HAVE AN AUTOPILOT INSTALLED ON YOUR BOAT, YOU SHOULD MONITOR THE LOCATION OF THE ENGINE CABLES AND AUTOPILOT BRACKETS AS THE ENGINES ARE TILTED TO DETERMINE THE BEST ENGINE POSITION AND MAXIMUM ENGINE TILT FOR YOUR APPLICATION.

4.5 Engine Stop Switch

Your boat is equipped with an engine stop switch and lanyard. When the lanyard is pulled it will engage the switch and shut off the engines. We strongly recommend that the lanyard be attached to the driver whenever the engines are running.

If an engine will not start, it could be because the lanyard is not properly inserted into the engine stop switch. Always make sure the lanyard is properly attached to the engine stop switch before attempting to start the engines.

Refer to the engine owner's manual for more information on the engine stop switch.

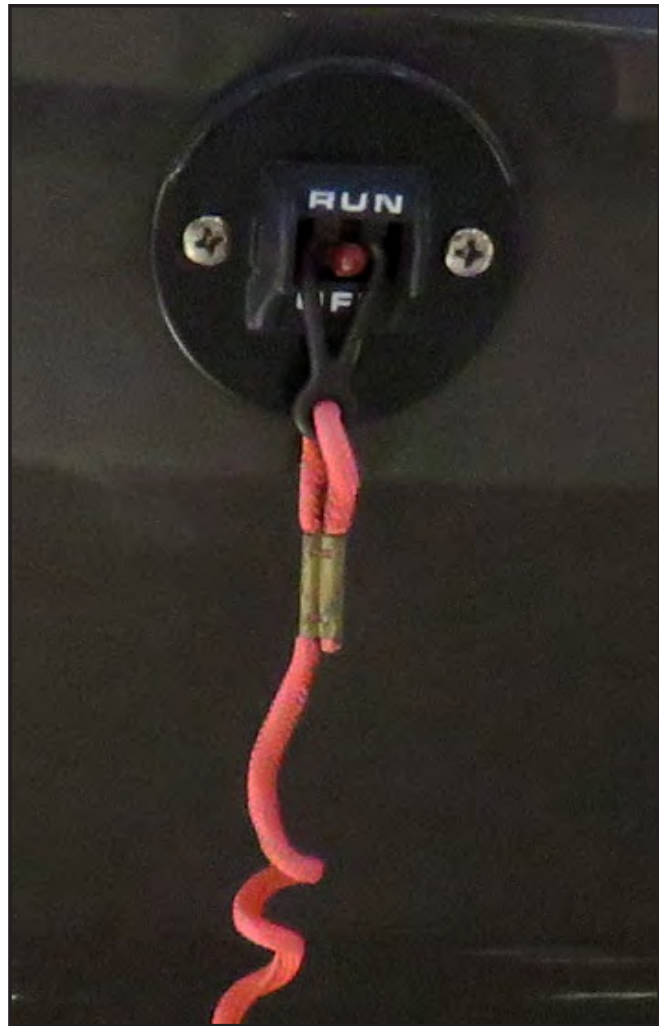

Mercury Engine Stop Switch & Lanyard

4.6 Steering System

Power Assist Hydraulic Steering

Power assisted steering systems on twin engine boats without the joystick option are hydraulic and comprised of two hydraulic circuits: a manual system, which is the control element, and a hydraulic power assist pump, which is the working element.

The manual system is hydraulic and made of three main components: the helm assembly, hydraulic hoses and the steering cylinders. The fluid reservoir for the system is built into the power assist pump assembly and the helm acts as a pump. Turning of the steering wheel, pumps fluid through the hydraulic hoses and activates the hydraulic steering cylinders causing the motors to turn. A slight clicking sound may be heard as the wheel is turned. This sound is the opening and closing of valves in the helm pump unit and is normal.

The power system is an electronically controlled, 12 volt hydraulic pump that boosts the fluid pressure being sent from the helm pump to the steering cylinders to provide "Power" for the steering system which results in much easier effort at the steering wheel, even under heavy loads. In the event of a power loss or failure of the hydraulic steering pump, the steering system will automatically revert to a manual hydraulic system. The manual system operates as described previously in this section and will require more effort on the steering wheel to turn the motors.

Steering Cylinders and Tie Bar

Some outboards are coupled near the tiller arms by a tie bar and controlled by one or two steering cylinders, depending on the options selected. The engines must be aligned to provide maximum stability on straight ahead runs and proper tracking through corners. Dual outboards are aligned so the engines are towed in slightly (.25" to .5") at the propellers. Engine or steering system damage may require the engines to be realigned.

Electronic Steering (Optional)

Your boat could be equipped with an electronic steering system that provides precise and responsive steering. Electronic steering is available with or without a joystick control.

The system is 100% electronic and there are no mechanical connections between the steering wheel and the engines. Each engine is turned independently allowing improved tight quarter



Typical Mercury Steering System Power Assist Pump



Mercury Engines With Electronic Steering

maneuvering and the convenience of an optional Joystick control at the helm.

For safety and improved tight quarter maneuvering, the controlling software on most systems senses engine speed and adjusts maximum steering angle and steering wheel resistance to preset limits as the engine speed increases or decreases.

Helm Control Systems

Steering angles and steering wheel resistance at specific engine speeds are programmed into the system at the factory and are not adjustable. The steering on each motor is totally independent with full redundancy built into the system. If the steering fails on one engine, the other unit will continue to operate. Should a failure in one steering system occur, the controlling software will sense the failure, limit the engine RPM as a safety precaution and alert the operator.

Each steering control system has emergency procedures that are specific to the steering system and type of failure. It is very important to follow the correct procedure to avoid damage to the engine cowlings if a steering system failure occurs.

Refer to the engine manufacturer owner's manuals for specific information on the operation, maintenance and emergency procedures for the steering system installed in your boat.

Tilt Steering Wheel

The steering wheel can be tilted to five different positions by activating the tilt lock lever located on the bottom of the helm station. When the lever is released, it automatically locks the steering wheel at or close to that angle. Refer to the steering manufacturer owner's manual for specific information on the steering system.



Typical Mercury Electronic Steering Pump



Typical Tilt Steering Wheel

4.7 Joystick Controls

A joystick control system is an option on some engine installations with electronic steering. The joystick can only be used at slow speeds. It is engaged by moving the shift and throttle controls to the neutral position and pressing the ON/OFF button on the base of the joystick control or the keypad on the main engine controls. Once activated, the boat moves in the direction the joystick is pushed with the engine speed increasing the further the stick is pushed, up to preset limits. Turning the knob on the top of the joystick rotates the boat in the direction the knob is turned. Another button on the joystick or engine control key pad raises the preset engine speed for maneuvering in high winds and/or strong tides.

When the joystick is released, it automatically returns to center, the engines shift to neutral, rotate to the straight ahead position, and the engine speed is reduced to idle. It is deactivated by pressing the ON/OFF button at the base of the joystick or control keypad or by moving the shift and throttle control levers.

Both engines must be running for the joystick control to maneuver boat properly.

Always refer to the engine manufacturer owner's manuals for specific information on the operation and maintenance for the joystick and steering control systems on your boat.



Typical Mercury Joystick & Skyhook Feature

DANGER

SOME JOYSTICKS AND ELECTRONIC CONTROL SYSTEMS ARE EQUIPPED WITH A "SKYHOOK" FEATURE WHICH USES THE ENGINES TO AUTOMATICALLY HOLD THE BOAT IN POSITION. THIS FEATURE CAN CAUSE SERIOUS INJURY OR DEATH TO PERSONS SWIMMING NEAR THE BOAT OR ATTEMPTING TO BOARD WHEN IT IS ACTIVATED.

WHEN SKYHOOK IS ACTIVATED:
THE PROPELLERS ROTATE AUTOMATICALLY;
PROPELLER ROTATION MAY NOT BE OBVIOUS;
THE BOAT MAY SUDDENLY MOVE IN ANY DIRECTION;
THE PROPELLERS CAN INJURE PEOPLE IN THE WATER ANYWHERE AROUND THE BOAT.

IF YOUR BOAT IS EQUIPPED WITH "SKYHOOK," THE FOLLOWING PRECAUTIONS APPLY:

ALWAYS ASK THE CAPTAIN BEFORE ENTERING THE WATER.

UNLESS THE CAPTAIN GIVES YOU PERMISSION:
DO NOT GO IN THE WATER; WIND OR WATER CURRENT CAN MOVE SWIMMERS INTO THE PROPELLERS.
DO NOT SIT OR STAND WHERE YOU COULD FALL OVERBOARD; YOU MAY LOSE YOUR BALANCE IF THE BOAT MOVES SUDDENLY.



Typical Yamaha Joystick

Helm Control Systems

4.8 Trim Tabs

The trim tabs are mounted to the hull below the swim platform and integrated transom engine mounting system. A dual rocker switch is used to control the trim tabs. The switch controls bow up and down movements. It also controls starboard and port up and down movements. Bow up and bow down will control the hull planing attitude, while port and starboard up and down provides control for the hull listing.

An LED indicator built into the switch displays the position of the trim tabs. When one LED is flashing at the top of the display, the tabs are in the "full-up" (bow up) position. When all LED lights are lit from the top to the bottom of the display, the tabs are fully extended (bow down).

The trim tabs are programmed to automatically retract after a one minute delay when the engines are shutdown to keep the actuators clean and set the tabs in the full "UP" position when leaving the dock. Refer to the trim tab operating manual for more information on the operation and programming of the trim tabs.

Before leaving the dock or lifting the boat with a forklift, make sure that the tabs are in the full "UP" position. If they are not, press and hold the control in the bow up position for ten (10) seconds to fully retract the tabs.

Always establish the intended heading and cruise speed before attempting to adjust the hull attitude with the trim tabs. After stabilizing speed and direction, move the trim tabs to achieve a level side to side running attitude being careful not to over trim.

After depressing a trim tab switch, always wait a few seconds for the change in the trim plane to take effect. Avoid depressing the switch while awaiting the trim plane reaction. By the time the effect is noticeable the trim tab plane will have moved too far and thus the boat will be in an overcompensated position.

When running at a speed that will result in the boat falling off plane, lowering the tabs slightly, bow down, will improve the running angle and operating efficiency. Too much bow down tabs can reduce operating efficiency and cause substantial steering and handling difficulties.



Lenco Trim Tab Control Switch



Trim Tab Plane & Actuator

Be extremely careful when operating in a following sea. The effect of trim tabs is amplified under such conditions. Steering and handling difficulties can result from improper trim tab usage, particularly in a following sea. Always raise the tabs to the full bow up position in these conditions.

When running at high speeds be sure that the tabs are in the full "UP" position. Only enough trim plane action should be used to compensate for any listing. Trim tabs are extremely sensitive at high speeds. Adjust for this and be prepared to slow down if difficulties arise.

When running into a chop, a slight bow down attitude will improve the ride. Be careful not to over trim. Handling difficulties may result.



4.9 Control Systems Maintenance

Control Maintenance

Periodic inspection of the control systems and all connections should be made. Signs of rust, corrosion, wear or other deterioration should immediately be serviced. Generally, periodic lubrication of all moving parts and connections with a light waterproof grease is in order.

Lubrication should be performed as often as necessary to keep the system operating smoothly.

Control system adjustments may become necessary. If adjustments become necessary, see your Crevale dealer.

	WARNING	
<p>DO NOT ATTEMPT CONTROL ADJUSTMENTS UNLESS YOU ARE FAMILIAR WITH SERVICING CONTROL SYSTEM PROCEDURES. CONTROL MISADJUSTMENT CAN CAUSE LOSS OF CONTROL AND SEVERE ENGINE OR LOWER UNIT DAMAGE.</p>		

Hydraulic Steering System Maintenance

A periodic inspection of all steering hoses, linkage and helm assemblies should be made. Signs of corrosion, cracking, loosening of fasteners, excessive wear or deterioration should be corrected immediately.

The fluid level for the hydraulic steering should be checked frequently and maintained at the proper level. The steering fluid level should be maintained at no less than 1/2" below the bottom of the fill plug hole on the hydraulic power assist pump reservoir located in the mechanical systems compartment. Only use power steering fluid recommended by the steering system manufacturer when adding fluid.

If your boat is equipped with an after market tower, the procedure for checking the steering fluid level and adding fluid may be different. Refer to the steering system manual for instructions on checking and filling the steering system on your boat.



Generally, periodic lubrication of all moving parts and connections with a light waterproof grease is in order. Check the hydraulic hoses and fittings for chaffing, rub marks and leaks. Replace if necessary. Failure to do so could lead to steering system failure that would result in loss of control. When new or after repairs, hydraulic steering systems may need to have all air purged from the system. Only use hydraulic steering fluid recommended by the steering system manufacturer. Difficult steering and premature seal failure can result if the wrong fluid is used in the steering system. Review the information provided by the steering system manufacturer for proper specifications and details on system service and maintenance.

Electronic Steering and Control Systems Maintenance

Electronic steering and control systems are supplied by the engine manufacturer. The systems have maintenance requirements that are specific to the engines and control options installed in your boat.

You should refer to the engine and controls systems owner's manuals for information and maintenance on the control and steering system installed in your boat. Their recommendations should be followed exactly.

The engine controls and steering systems are fully electronic and activated by micro processors and controlling software in each engine controller. If adjustment becomes necessary do not attempt to address the problem yourself. You should contact your Crevale or outboard engine dealer for assistance.

	WARNING	
<p>IMPROPERLY ADJUSTED ELECTRONIC ENGINE CONTROLS CAN CAUSE LOSS OF CONTROL AND SEVERE ENGINE DAMAGE. IF YOUR CONTROLS ARE NOT OPERATING PROPERLY, DO NOT ATTEMPT CONTROL SYSTEM ADJUSTMENTS YOURSELF. CONTACT YOUR CREVALLE OR ENGINE DEALER FOR ASSISTANCE AND DO NOT USE THE BOAT UNTIL THE SITUATION IS CORRECTED.</p>		

Helm Control Systems

Engine Lubrication

Please refer to the engine owner's manual for maintenance and lubrication instructions for the outboard engines.

Trim Tab Maintenance

The trim tab actuators are electric and require no routine maintenance except to periodically inspect the tab actuators for corrosion or marine growth and test the system to ensure that it is operating properly.

Marine growth can interfere with the proper operation of the trim tab planes and actuators. To reduce problems due to marine growth, always return the trim tabs to the full "UP" position after operating the boat and periodically inspect and clean marine growth from the actuators and planes.

If the boat is kept in the water, the trim tab planes must be equipped with a sacrificial anode to prevent galvanic corrosion. Galvanic corrosion is the corrosion process occurring when different metals are submerged in an electrolyte. Seawater is an electrolyte and submerged metal components must be properly protected. The anodes will need to be changed when they are 75% of their original size (25% depleted). Refer to the Routine Maintenance chapter of this manual for information on maintaining sacrificial anodes.

To discourage any marine growth on the tabs or actuators, antifouling paint can be applied. When applying paint to the actuators, make sure they are fully retracted. Do not paint the stainless ram above the area that is exposed when fully retracted. The bottom paint will damage the O-ring seals when the ram is retracted and allow seawater to

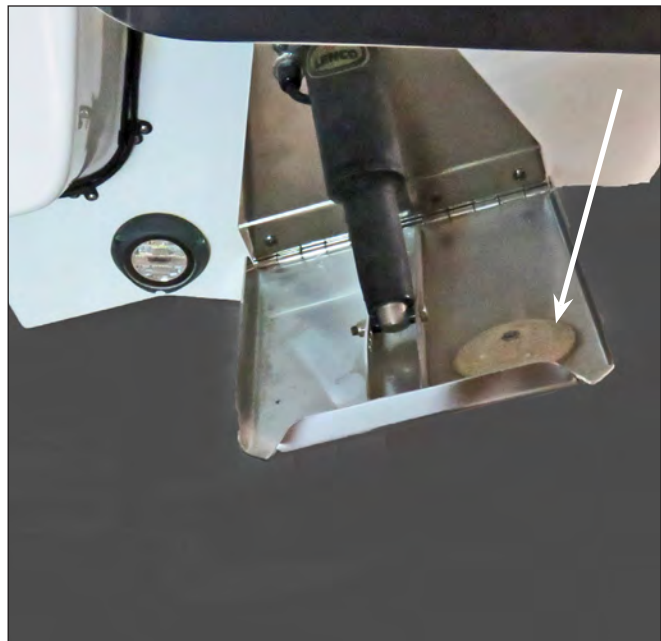

Trim Tab Actuators, Plane & Anode

enter the actuator motor. When painting the trim tabs, do not apply paint to the sacrificial anodes or the mounting surface under the anode. The sacrificial anode must have full metal to metal contact with the trim tab plane or it will become ineffective. Contact your dealer or the trim tab manufacturer for information regarding the correct bottom paint for the trim tabs.

Refer to the trim tab owner's manual for additional maintenance information, specifications, troubleshooting and operating instructions.

5.1 Gasoline Fuel Systems



General

The Gasoline fuel system used in Crevalle boats is designed to meet or exceed the emission control standards of the U.S. Environmental Protection Agency (EPA) and the requirements of the U.S. Coast Guard, the Boating Industry Association and the American Boat and Yacht Council in effect at the time of manufacture.

Notice:

This boat is equipped with an EPA compliant fuel system. Do not alter or bypass any of the components that are installed. See your dealer for any fuel related service.

All gasoline fuel systems have been factory inspected and pressure tested in accordance with regulations in effect at the time of manufacture. This inspection assures that the system is air tight, leak proof and safe. It is the responsibility of the purchaser to maintain it in that condition. Make frequent inspections to assure that no deterioration or loosening of connections is resulting from vibration.

	DANGER	
<p>DO NOT LET THE ODOR OF GASOLINE GO UNCHECKED. ANY ODOR OF GASOLINE MUST BE IMMEDIATELY INVESTIGATED AND STEPS TAKEN TO PROTECT THE BOAT AND ITS OCCUPANTS UNTIL THE PROBLEM IS CORRECTED. IF THE ODOR OF GASOLINE IS NOTICED, SHUT OFF ALL ENGINE AND ELECTRICAL EQUIPMENT. INVESTIGATE AND CORRECT THE SITUATION IMMEDIATELY. HAVE ALL PASSENGERS PUT ON PERSONAL FLOTATION DEVICES AND KEEP A FIRE EXTINGUISHER READY UNTIL THE SITUATION IS RESOLVED.</p>		

Fuel Withdrawal Tubes

The fuel withdrawal tubes are positioned in the fuel tank to achieve optimum fuel usage, fuel line routing, etc. At certain speeds and hull trim angles, the fuel supply at the withdrawal tank location can increase or decrease accordingly. Be extremely careful when attempting to operate the boat when low on fuel. Though some fuel may be in the tank, the relative trim angle of the boat may cause fuel to flow away from the withdrawal tubes.



Fuel Fill

Fuel Gauge

Indicates the amount of fuel in the tank. Due to the mechanical nature of the fuel sender, variations in readings during various speeds of operation may occur. This system is merely a relative indication of available fuel supply and not a calibrated instrument.

Fuel Fill & Vent System

In order to comply with U.S. EPA emission regulations, your boat is equipped with a special fuel system that does not vent directly to the atmosphere. The system is equipped with a "keyless" fuel cap located on the port gunnel that is marked "GAS." The fill cap is not vented and the fill system is completely sealed when the cap is closed.

There is a fuel tank vent built into the fuel fill. Another vent equipped with vapor emission control components in the hull side provides ventilation for the tank when the fuel fill system is sealed. While the tank is being filled, most air displaced by the fuel escapes through the fuel fill vent. The fuel fill and vent system are designed such that an automatic shutoff valve in the marina fuel pump nozzle will stop the flow before fuel can be ejected into the vent system when the tank is full. You should never attempt to "top off" the tank after the pump nozzle shutoff valve has activated. This could force fuel into the vent system and damage emission control components.

Fuel System

The fuel fill cap is opened by turning the cap counter clockwise until it can be removed. After refueling, replace the fill cap and tighten until it clicks, indicating that the cap has been properly closed and the fill system is sealed. Wash the areas around the fuel fill if any fuel splashed on the deck or hull during filling operations. Residual fuel left on the deck and hull sides can be dangerous and will yellow the fiberglass or damage the striping.

Be sure to use the proper type and grade fuel. Refer to the engine owner's manual for additional information.



Typical Mercury Fuel Filters



WARNING



DO NOT CONFUSE FUEL FILL DECK PLATE WITH THE WATER OR WASTE FILL DECK PLATES. THESE PLATES ARE ALSO LABELED ACCORDINGLY. IF GASOLINE IS ACCIDENTALLY PUMPED INTO THE WATER OR WASTE TANK, DO NOT ATTEMPT TO PUMP IT OUT YOURSELF. WATER AND WASTE PUMPS ARE NOT DESIGNED TO PUMP FUEL AND A FIRE OR EXPLOSION COULD RESULT. CONTACT YOUR DEALER OR THE CREVALLE CUSTOMER SERVICE DEPARTMENT FOR ASSISTANCE IN HAVING THE FUEL PROFESSIONALLY REMOVED.

Fuel Tank Vent

In order to comply with U.S. EPA regulations, the fuel tank is equipped with a special vent located on the hull side and vent system emission control components. A carbon filled canister in the vent hose between the fuel tank and the vent absorbs fuel vapors before they can escape to the atmosphere and returns them to the fuel tank.

Carbon canisters can be damaged if they are repeatedly exposed to liquid fuel. Special valves in the vent system and the automatic shutoff valve on marina fuel pump nozzles prevent the tank from being overfilled and forcing fuel into the vent system. You should never attempt to "top off" the tank after the pump nozzle shutoff has activated. This could force fuel into the vent system that can damage the carbon canister or other components.

5.2 Engine Fuel Delivery System

The fuel system has one fuel tank located in the center of the bilge below the cockpit sole. The tank is equipped with two fuel withdrawal tubes. Each fuel withdrawal line is equipped with an anti-siphon valve where the line attaches to the fuel tank. This valve prevents gasoline from siphoning out of the fuel tank should a line rupture.



CAUTION



DO NOT REMOVE THE ANTI-SIPHON VALVES FROM THE SYSTEM. SHOULD THE VALVE BECOME CLOGGED, CLEAN AND REINSTALL OR REPLACE.



A fuel filter for each engine is installed in the aft systems compartment bilge. The filters are accessed by opening the rear hatch in the cockpit sole. They are the water separator type and should be serviced frequently to assure an adequate supply of clean, dry fuel to the engines. It is recommended that the filters are inspected periodically and the elements changed as needed.



There is usually a primer bulb in the fuel line near each fuel filter that is used to prime the fuel system after service or as required. See Fuel System Maintenance and the engine owner's manual for additional information on the fuel filters and the outboard engine fuel system.



Notice:

The procedure to prime the fuel system on outboard engines is specific to the type and model of engines on your boat. You should refer to engine manufacturer owner's manual for the priming procedure for your engines.

5.3 Fueling Instructions



	WARNING	
<p>FUEL IS VERY FLAMMABLE. BE CAREFUL WHEN FILLING THE FUEL TANK. NO SMOKING. NEVER FILL THE TANK WHILE AN ENGINE IS RUNNING. FILL THE FUEL TANK IN AN OPEN AREA. DO NOT FILL THE TANK NEAR OPEN FLAMES.</p>		

	CAUTION	
<p>TO PREVENT DAMAGE TO THE FUEL SYSTEM, USE ONLY A GOOD GRADE OF GASOLINE FOR OUTBOARD ENGINES. DO NOT USE A FUEL THAT CONTAINS HARSH ADDITIVES OR IS AN ALCOHOL BLEND OF A HIGHER CONCENTRATION THAT RECOMMENDED BY THE ENGINE MANUFACTURER. ANY DAMAGE DONE TO THE FUEL SYSTEM THAT IS THE RESULT OF USE OF AN ALCOHOL BLEND, IS NOT COVERED BY THE CREVALLE WARRANTY. REFER TO THE ENGINE MANUFACTURER OWNER'S MANUAL FOR THE FUEL REQUIREMENTS FOR YOUR ENGINES.</p>		

	WARNING	
<p>DO NOT CONFUSE FUEL FILL DECK PLATE WITH THE WATER OR WASTE FILL DECK PLATES. THESE PLATES ARE ALSO LABELED ACCORDINGLY. IF GASOLINE IS ACCIDENTALLY PUMPED INTO THE WATER OR WASTE TANK, DO NOT ATTEMPT TO PUMP IT OUT YOURSELF. WATER AND WASTE PUMPS ARE NOT DESIGNED TO PUMP FUEL AND A FIRE OR EXPLOSION COULD RESULT. CONTACT YOUR DEALER OR THE CREVALLE CUSTOMER SERVICE DEPARTMENT FOR ASSISTANCE IN HAVING THE FUEL PROFESSIONALLY REMOVED.</p>		

Preparing The Boat For Fueling

- Make sure all switches are in the OFF position.
- Make sure the boat is securely moored.
- Make sure all passengers leave the boat.
- Close all doors and hatches to prevent fuel fumes from entering the console or bilge.
- Estimate how much fuel is needed and avoid over filling the tank.

	WARNING	
<p>STATIC ELECTRICITY CAN BE GENERATED WHILE FUELING AND CAN CAUSE A FIRE OR EXPLOSION. TO PREVENT STATIC SPARKS WHEN FILLING THE TANK, MAKE SURE THE NOZZLE IS IN CONTACT WITH THE FUEL OPENING.</p>		

Fueling Instructions

In order to comply with U.S. EPA emission regulations, your boat is equipped with a special fuel system that prevents fuel vapors from entering the atmosphere when fueling operations are complete.

These fuel systems meet U.S. EPA emission standards and are designed to maintain a specific air space at the top of the fuel tank that provides proper tank ventilation and protection for emission control components. Special valves in the fuel tank vent system, the fuel fill and a shutoff valve in marina fuel pump nozzles are designed to automatically stop the fuel flow when the tank is full and maintain this air space.

Notice:

When the fuel tank is full, the shutoff valve in the marina fuel pump nozzle will activate and automatically shut off the flow, indicating that the tank is filled to the maximum level. You should stop filling the tank at this point and never attempt to "top off" the tank. Attempting to "top off" the tank could damage fuel level control valves or force fuel into the vent system which could damage vapor emission control components.

Filling The Fuel Tank:

- The fuel cap is designed to be opened by hand and does not require a key. Turn the cap counterclockwise to remove it for fueling.
- Make sure the fuel pump nozzle is equipped with an automatic shutoff valve. Then put the nozzle in the fuel fill opening and make sure it stays in contact with the fuel fill fitting during the entire fueling operation.
- Fill the tank until the nozzle shutoff valve clicks and automatically stops the fuel flow.
- Remove the nozzle.
- Install the fuel cap and tighten until the cap clicks, indicating that the cap is tight and the system is sealed.

Fuel System



WARNING



SPILLED FUEL CAN CAUSE A FIRE OR AN EXPLOSION. MAKE SURE YOU DO NOT SPILL ANY FUEL. IF A SMALL AMOUNT OF FUEL IS SPILLED ON THE FIBERGLASS, USE A CLOTH TO REMOVE THE FUEL AND PROPERLY DISPOSE OF THE CONTAMINATED CLOTH. IF FUEL IS SPILLED ON THE WATER, EXERCISE EXTREME CAUTION. FUEL FLOATS ON THE SURFACE OF THE WATER AND CAN IGNITE. IF FUEL IS SPILLED INTO THE WATER, IMMEDIATELY EVACUATE THE AREA AND NOTIFY THE MARINA AND THE PROPER OFFICIALS.

Preparing the Boat for Operation

Use the following procedure to prepare the boat for operation when fuel operations are complete:

- Open all hatches, windows and doors.
- Check the fuel compartment and below the deck for fuel odors. If you smell fuel, do not start the engine.



DANGER



GASOLINE FUEL VAPORS THAT ACCUMULATE IN THE BILGE COMPARTMENT WHILE FUELING CAN EXPLODE!! TO REDUCE THE RISK OF A FIRE AND/OR EXPLOSION AFTER FILLING THE FUEL TANK, ALWAYS OPEN ALL HATCHES, WINDOWS, AND DOORS TO COMPLETELY VENTILATE THE BOAT BEFORE STARTING THE ENGINE.

5.4 Fuel System Maintenance

Periodically inspect all connections, clamps and hoses for leakage and damage or deterioration. Replace as necessary. Spray the valves, tank fuel gauge sender and ground connections with a metal protector.

Frequently inspect and lubricate the fuel fill cap O-ring seal with Teflon or silicone grease. The O-ring seal prevents water from entering the fuel system through the fuel fill cap and should be replaced immediately if there is any sign of damage or deterioration.

Contaminated fuel may cause serious damage to your engine. Fuel filters must be checked for water and other contamination frequently. Engine filters must be changed at least once each year or more frequently depending on the type of engine

and the quality of the fuel. Refer to the engine manufacturer's instructions for information on servicing and replacing the fuel filter elements.

The age of gasoline can affect engine performance. Chemical changes occur as the gasoline ages that can cause deposits and varnish in the fuel system as well as reduce the octane rating of the fuel. Severely degraded fuel can damage engines and boat fuel tank and lines. Therefore, if your boat is not being run enough to require at least one full tank of fresh fuel a month, a fuel stabilizer should be added to the gasoline to protect the fuel from degradation. Your dealer or the engine manufacturer can provide additional information on fuel degradation and fuel stabilizers recommended for your engine.

In many states, most gasoline is blended with ethanol alcohol. Ethanol is a strong solvent and can absorb water during periods of storage. You should refer to the engine operating manual for information regarding alcohol blended fuels and how it affects the operation of your marine engine.



WARNING



AFTER THE FILTER ELEMENT HAS BEEN CHANGED, PRIME THE FUEL SYSTEM AND CHECK ALL FITTINGS FOR LEAKS BEFORE AND AFTER STARTING THE ENGINE FOLLOWING ANY FUEL SYSTEM SERVICE.



WARNING



TO REDUCE THE POSSIBILITY OF A FIRE OR EXPLOSION, MAKE SURE ALL ELECTRICAL SWITCHES ARE IN THE "OFF" POSITION BEFORE SERVICING THE FUEL SYSTEM.



WARNING



BEFORE STARTING THE ENGINES, ALWAYS OPEN ALL HATCHES AND DOORS TO COMPLETELY VENTILATE THE BOAT AFTER SERVICING THE FUEL SYSTEM.



DANGER



AVOID SERIOUS INJURY OR DEATH FROM FIRE OR EXPLOSION RESULTING FROM LEAKING FUEL, INSPECT SYSTEM FOR LEAKS AT LEAST ONCE A YEAR. DO NOT DRAIN ANY FUEL INTO THE BILGE.

6.1 General

Your boat is equipped with a 12 volt DC electrical system and a 120 volt AC battery charging system. The battery charger draws current from a shore power outlet at dockside. The DC system draws current from onboard batteries.

Boats equipped with the optional trolling motor will also have a 36 volt DC electrical system dedicated to the trolling motor. The 36 volt system draws current from three onboard batteries that are completely isolated from the boat's 12 volt system.

All wires in the electrical system are color coded to make identifying circuits easier. Wiring schematics have been included with this manual to aid in following an individual circuit of the boat.

The boat and engine charging systems are designed for 12 volt, lead acid wet cell or absorbed glass mat (AGM) batteries. Most wet cell batteries will require similar maintenance as those in automobiles. AGM and some wet cell batteries are sealed and require no maintenance except to periodically clean battery tops, terminal posts and connections.

It is important that you know the type of batteries in your boat and that the engine charging system and battery charger are set to recharge these batteries. Charging systems not set to the proper battery type could cause unusually short battery life, engine starting problems and damage to the DC charging systems. You also should not mix the brand or type of batteries.

The batteries in your boat were installed by the dealer. They should be of the size and capacity recommended by the manufacturer of your engines. Labels on the battery cables indicate the specifications for the batteries required to power the house and engine electrical systems. Refer to the engine owner's manual for more information on battery requirements. These specifications should be considered to be the minimum size battery required.

Always consult your dealer before changing the type of batteries in your boat or if you have questions regarding the batteries.



6.2 12 Volt DC System

The 12 volt system is a standard twin engine marine system. There are four batteries, one for the starboard engine, one for the port engine and two wired in parallel for the house, accessory circuits and electronics. The batteries themselves can be charged by the engines or the battery charger, when connected to shore power.

Automatic battery isolator/relays (DVSR) manage the charging current for the engine and house batteries. The system is equipped with a battery parallel feature that will connect both engine starting batteries or an engine starting battery and the house batteries in parallel for extra battery power while starting an engine.

Most 12 volt power is distributed to the accessories through individual circuit breakers located in the battery switch panel. Heavy duty circuit breakers located near the battery switches protect the main accessory circuit, windlass, optional air conditioner, refrigerator and stereo amplifier. Other circuit breakers or fuses protect the circuits for the battery charger DC circuits, stereo and electronics memory, engine control memory, and automatic switches for the bilge pumps. Fuses located on each engine protect the ignition, charging systems and gauges. Other fuses provided by the engine manufacturer protect auxiliary charging circuits and other engine related electronic controls.

Some 12 volt accessories are operated directly by a circuit breaker in the breaker panel while others are operated by a switch fed by the breaker. Most of the 12 volt accessories on the deck and in the cockpit are operated by switches in the helm switch panels.

	CAUTION	
<p>PROPER FUSE OR BREAKER PROTECTION MUST BE PROVIDED FOR ALL 12 VOLT EQUIPMENT ADDED. DO NOT OVERLOAD THE ACCESSORY CIRCUIT BREAKERS OR OTHER CIRCUITRY THROUGH ADDITIONAL 12 VOLT EQUIPMENT.</p>		

Electrical System



Battery Switch Panel, Battery Switches, Main Circuit Breakers & Accessory Breakers

6.3 Batteries & Battery Switches

There are four batteries located behind an access door in the helm seat base. Three battery switches are located in the compartment above the batteries. There is a battery switch for each engine and a switch for house accessory circuits. Each switch has OFF, ON and COMBINE BATTERIES positions.

Automatic battery isolator/relays (DVSR) manage the charging current for the engine and house batteries. Whenever the engines are running, the isolator/relays automatically sense the condition of each battery and direct the available current to the batteries that require charging. Any two battery banks can be temporarily connected in parallel by setting any two battery switches to the COMBINE BATTERIES position to provide additional starting current for an engine.

When in port or at anchor, the port and starboard engine battery switches should be off. Only the battery switch that activates the house and accessory circuits should be on. This will keep both

engine starting batteries in reserve for starting the engines. If the house batteries become discharged to the point that accessories stop operating properly, the engines can be started to recharge the house batteries.

Notice:

Current is supplied to the automatic float switches for the bilge pumps and high water alarm when the batteries are connected and the battery switches are off.

Once the engines are running, the alternators will charge each engine starting battery. As the voltage in the battery raises to a preset level, the automatic isolator relay between each engine battery and the house batteries will close and direct charging current to the house batteries. The engine starting and house batteries will continue to be charged until the engines are shutdown and the automatic relays open, isolating the house batteries from the engine batteries.



Part Engine & House Battery Switches in Parallel (COMBINED BATTERIES) Position

6.4 Parallel Switch & Dead Batteries Dead Engine Starting Battery

In the event of a dead engine battery, the engine starting batteries or engine and house batteries can be placed in a temporary parallel configuration. This allows you to start an engine from two battery banks combined.

To connect the engine batteries in parallel to start the engines, turn both engine battery switches to the COMBINED BATTERIES position and start each engine. Once the engines have started and systems have stabilized, turn both switches to the ON position to isolate the circuits.

To connect the port engine battery in parallel with the house batteries to start the engine, turn the house and port engine battery switches to the COMBINED BATTERIES position and start the engine. Once the engine has started and systems have stabilized, turn both switches to the ON position, to isolate the circuits.

To connect the starboard engine battery in parallel with the house batteries to start the engine, turn the house and starboard engine battery switches to the COMBINED BATTERIES position and start

the engine. Once the engine has started and systems have stabilized, turn both switches to the ON position to isolate the circuits.

Dead House Batteries

In the event of dead house batteries, there are a couple options:

- If at the dock, simply plug in the shore power and operate the battery charger to recharge the house batteries.
- If at sea, start one or both engines. Once an engine is running, the DVSR circuit will sense low voltage in the house battery bank and direct available current to charge the house batteries. Operating both engines will recharge the house batteries much quicker. The batteries will continue to be charged until the engine or engines are shutdown, isolating the house batteries from the engine batteries.

Notice:

If a battery is fully discharged/dead for a lengthy period, it may become permanently damaged and will not be able to hold a charge.

Electrical System

6.5 Ignition Switch Panels

Ignition Switch Panels

Ignition switch panels are unique to each engine manufacturer and the engine control options selected. Your dealer will provide you with the proper starting procedure for your boat at the time of delivery. Additional information for the ignition switch system installed in your boat is located in the engine and control system operating manuals included in your information packet.

The following instructions are an overview for Yamaha and Mercury ignition switch panels commonly installed on Crevalle boats. Your boat may be different depending on the options selected.

Yamaha Command Link Plus® Ignition

Command Link Plus® ignition panels are “key” panels; which energize the ignition system of multiple outboards with only one key.

The Start/Stop panel is used in conjunction with the key panel and features lights which indicate when outboards are running and a START/STOP button for each engine. This system greatly simplifies the starting and stopping process of your engines. For convenience and protection, engines can not be restarted while running.

Starting procedure

Make sure the engines are down with the shift lever in the neutral position and your hand is on the control lever. Turn the ignition key to the ON position to activate the START button for both engines. Press and release the START/STOP button for the port engine. The computer will automatically check all engine systems and start the engine. When the engine stabilizes, repeat the starting procedure for the starboard engine.

Stop the engines by pressing the START/STOP buttons again. Disable the START/STOP panel by turning the key switch off.

Notice:

Boats equipped with Auto Retract Trim Tabs will automatically retract the tabs when the ignition switches are turned off.

Helm Master Keyless Ignition

Some boats equipped with Yamaha engines include the Helm Master ignition panel that offers the latest technology and security. This is a “keyless” electronic panel which energizes the ignition system of multiple outboards with only one Radio Frequency ID key by touching the panel



Typical Twin Engine Yamaha Command Link Ignition & Engine START/STOP Switch System



Yamaha Digital Ignition Start/Stop Buttons

with the electronic key. The panel features lights which indicate when the engines are running and a START/STOP button for each engine. For convenience and protection, engines can not be restarted while running.

Starting And Stopping Procedure

Make sure the engines are down with the shift lever in the neutral position and your hand is on the control lever. Touch the panel with the electronic key fob to unlock and activate the panel. The panel

will beep twice to indicate it is unlocked and the buttons are active. Once the panel is activated, press the IGNITION button, then the START/STOP button for the port engine. It is not necessary to hold the button, just press it once and release it. The computer will automatically check all engine systems and start the engine. Once the engine stabilizes, repeat the starting procedure for the other engine. Stop the engines by pressing the START/STOP buttons again. Touch the panel with the electronic key to deactivate and lock the panel. The panel will beep once to indicate that it is locked and the engines and START/STOP buttons are deactivated.

Mercury Digital Ignition

Mercury digital ignition panels are equipped with ON/OFF key switches located in the head compartment and a START/STOP panel at the helm.

The Start/Stop panel is used in conjunction with the key switches and features a START/STOP button for each engine. This system greatly simplifies the starting and stopping process of your engines. For convenience and protection, engines can not be restarted while running.

Starting Procedure

Make sure the engines are down with the shift lever in the neutral position and your hand is on the control lever. Turn each ignition key to the ON position to activate the START buttons for both engines.

Press and release the START/STOP button for the port engine. The computer will automatically check all engine systems and start the engine. When the engine stabilizes, repeat the starting procedure for the starboard engine.

Stop the engines by pressing the START/STOP buttons again. Disable the START/STOP panel by turning the key switches off.



Typical Mercury ON/OFF Key Switches



Mercury START/STOP Buttons



Typical Digital Switch Panel in Electronics Display

6.6 12 volt Accessory Switch Panels Digital Switch System

Your boat is equipped with a digital switching system that provides reduced complexity and increased switching options for the lights and accessories the switches control. The system consists of the display screens, control output modules, push button digital switch panels and touch screen switches in the helm electronics display panels.

Each circuit is protected by individual spade type fuses located in a fuse panel built into the control output module, other fuse panels near the module or push to reset circuit breakers in the battery switch panel. The control output module is where the switching of input and output current load to the selected accessories takes place. The controllers in the module recognize low voltage, digital signals from the switches and activate the correct programmed combination of circuits for each switch function (i.e. the navigation lights switch actually forces the forward navigation lights and the anchor light to be turned on at the same time).

Interior or cockpit light switches may be programmed to activate different colors for multicolored LED lights activated by the switches as well as their ON/OFF status. All switches in the push button switch panels are a "press to activate" and "press to deactivate" design. LED lights in each switch indicate the circuit is activated.

This section provides a general description of the accessories typically activated by the switch panels. Switch programming is unique to each boat, depending on optional equipment installed at the factory or by your dealer and display preferences chosen at the time of delivery. Consequently, switch programming on your boat may be different.

Refer to the digital switching system operation manual for additional information on the switching system. Your dealer and or Crevalle representative will also provide you with hands-on instructions at the time of delivery.



Helm Manual Switch Panel

Helm Manual Accessory Switch Panel

The manual accessory switch panel is located at the helm. Most “push to reset” circuit breakers that protect the accessories activated by the switches are located in the battery switch panel. Protection for other circuits is provided by spade fuses in the control module or other fuse panels near the module. An LED light built into the switches indicates that the circuit is activated.

If a breaker trips, the reset button pops out and can be felt through the protective cover. Press the button to reset the tripped breaker. If the breaker trips again, find and correct the problem before resetting the breaker.

If a fuse blows, it must be replaced with a fuse of the same amperage as the original. The fuses are labeled and color coded. Never try to correct a problem with a 12 volt accessory by installing a larger fuse. This could cause the accessory or circuit with a problem to overheat, which could result in an electrical fire.

The following is a description of the accessories controlled by the helm accessory switches:

Navigation Lights

Pressing the switch once will activate the navigation lights. Press the switch again to turn the lights off.

Cockpit Lights

Activates the lights below the gunnels that illuminate the cockpit sole. Press the switch once to activate the lights. Press the switch again to turn the lights off.

Bilge Pump

Manually activates the aft bilge pump located in the stern bilge near the transom. Pressing the switch once will activate the pump. Press the switch again to turn the pump off.

The pump moves water out through a thru-hull fitting in the hull. The pump is also activated by an automatic float switch that is activated whenever the batteries are connected. This pump will run as needed whenever the water in the bilge accumulates high enough to raise the float switch to the ON position and turn off when the water is removed.

Notice:

The bilge pumps will start automatically when there is sufficient water in the bilge to activate the float switch. Each float switch is protected by a labeled circuit breaker in the battery switch panel and are always supplied current when the batteries are connected.

Electrical System

Windlass UP/Windlass DOWN

Two momentary switches that control the windlass, which is mounted to the deck forward of the rope locker. Press and hold the Windlass Up switch to pull the anchor line in. Press and hold the Windlass Down switch to pay the anchor line out.

Vent Extend/Vent Retract

Two momentary switches that control the windshield vent. Press and hold the Vent Extend switch to open the vent. Press and hold the Vent Retract switch to close the vent.

Awning Extend/Awning Retract (Optional)

Two momentary switches that control the optional awning at the rear of the hardtop. Press and hold the Awning Extend switch to extend the awning. Press and hold the Awning Retract switch to retract the awning.

Limit switches in the electric actuators that extend and retract the sunshade will automatically stop the actuators when the sun shade reaches the fully extended or retracted positions.

Horn

A momentary switch that activates the boat horn.

Wiper

Activates the windshield wiper. Pressing the switch once will activate the wiper. Press the switch again to turn the wiper off.

Wiper Wash

A momentary switch that activates the solenoid that sprays water on the windshield from the wiper washer reservoir located above the forward bilge pump.

USB Connection

Typically located in the helm switch panel and in the bow seat area. Provides 2 charging sources for devices that can connect to a USB port. These do NOT connect audio to the boat stereo system.

Typical Helm Electronics Display Panel Switches

Accessory switches are integrated into the electronic display panels at the helm. The switches are typically activated by touching the switch icon to activate the accessory and touching the switch again to turn it off. LED lights in each switch icon illuminate to indicate the circuit is activated.

This section is a general overview of the digital switch programming for reference purposes. Switch programming is unique to each boat, depending on



Typical Digital Switch Panel in Display



Typical Interactive Light Switches



Interactive Light Switch Control Mode

the electronics selected and optional equipment installed at the factory or by your dealer. Displays will also vary depending on preferences chosen at the time of delivery.

Refer to the digital switching system operation manual for additional information on the switching

system installed on your boat. Your dealer will also provide you with hands-on instructions at the time of delivery.

Notice:

Some switches in the manual helm switch panel are duplicated in the electronics display panel for convenience. Switches can be added or deleted from the panel at the operator's discretion and your boat may be equipped with additional switches not mentioned.

The following is a description of accessory switches typically controlled by touch screen switches in the electronics display panel:

Poco Mode

POCO (Power Control) is a proprietary switching control for lighting built by Lumitec. When the boat is first powered on, POCO is turned off. Overhead, Cockpit, and Underwater Lights can be turned on at any time using the manual mechanical switches at the center of the helm. Note, however, that these lights will come on at white with full intensity. They cannot be dimmed or change their color until POCO mode is enabled.

Once the digital switching system is online, press the POCO button to transfer lighting control to the POCO module. At this point, use the Lumitec POCO screen to control the lighting throughout the boat.

If the light switch has a ring around it, it is considered a "smart" light meaning the user can change the light's intensity or color. If it has no ring, the light can only be turned on/off with no ability to change color or dim the light. To activate the smart light features, press and hold any light switch with a ring around it. A color selection widget will appear allowing the user to select a color, dim the lights, or change the lights to color changing spectrum rotation. Press the light switch at any time to turn the lights off. Should you wish to return the lights to manual control, press the Exit POCO button at the bottom of the light control page. This will turn off the POCO module and return lights to manual mode. NOTE: Some lights (spreader) only have 2 colors available and the color widget will reflect this.

There is a standard and advance lighting scenes tab at the top of the lighting page. The standard tab allows individual control of each light group with some combined lighting controls as well. The advanced lighting tab allows for more complicated lighting scenes with some default color combinations included.

Anchor Light

Activates the anchor light.

Nav Lights

Activates the navigation lights.

Livewell Lights

Activates the light in the livewells.

Bilge Light Switches

Activates the light in the aft bilge compartment.

OH Lts

Activates the overhead lights above the helm.

Cockpit Lts

Activates the lights below the gunnels that illuminate the cockpit sole.

Storage Lts

Activates the lights inside the cockpit storage compartments.

Underwater Lights

Activates the LED underwater lights in the stern below the waterline.

Spot Light

Activates the spot light mounted on the hardtop.

Fwd Bilge

Manually activates the forward bilge pump located in the bilge below the head compartment sole. The pump moves water out a thru-hull fitting in the hull. The pump is also activated by an automatic switch that is activated whenever the batteries are connected. This pump will run as needed whenever water in the bilge accumulates high enough to activate the automatic switch and turn off when the water is removed.

Aft Bilge

Manually activates the aft bilge pump located in the stern bilge near the transom. The pump moves water out a thru-hull fitting in the hull. The pump is also activated by an automatic switch that is activated whenever the batteries are connected. This pump will run as needed whenever water in the bilge accumulates high enough to activate the automatic switch and turn off when the water is removed.

Fresh Wtr Pump

Activates the fresh water pump that supplies the fresh water shower in the cockpit, marine toilet and sink in the head compartment and aft station sink. The pump is the pressure demand type. A pressure switch automatically controls the water pump when the system is activated and properly primed.

Electrical System

Wash Pump

Activates the raw water washdown pump that supplies the washdown hose in the cockpit. The pump is the pressure demand type. A pressure switch automatically controls the water pump when the system is activated and properly primed.

Fwd Livewell

Activates the pump for the forward livewell.

Port Livewell

Activates the pump for the port aft livewell.

Starboard Livewell

Activates the pump for the starboard aft livewell.

Port Fishbox Pump Out

Activates the pump that drains the port cockpit fishbox. To avoid damage to the pump, always monitor the water level as the pump drains the fishbox and turn it off immediately when draining is complete.

Starboard Fishbox Pump Out

Activates the pump that drains the starboard cockpit fishbox. To avoid damage to the pump, always monitor the water level as the pump drains the fishbox and turn it off immediately when draining is complete.

Wiper

Activates the windshield wiper.

Washer

Activates the solenoid that sprays water on the windshield from the reservoir located above the forward bilge pump.

Waste Pump

Activates the waste discharge pump that empties the waste tank. Refer to the Marine Head System in the Interior Equipment chapter for additional information on the operation of the overboard discharge system.

Spreader Lights

Activates all spreader lights in the hardtop.

Under Gunwale Light

Activates the lights below the gunnels that illuminate the cockpit sole.

Forward Storage Lights

Activates the lights under the forward seating port and starboard storage areas.

All Cockpit Lights

Activates all lights that illuminate the cockpit.



Trim Tab Control Switch

Speaker/Storage Lights

Activates the lights inside the cockpit storage compartments and speakers.

Vent Extend/Vent Retract

Two momentary switches that control the windshield vent. Press and hold the Vent Extend switch to open the vent. Press and hold the Vent Retract switch to close the vent.

Awning Extend/Awning Retract (Optional)

Two momentary switches that control the optional awning at the rear of the hardtop. Press and hold the Awning Extend switch to extend the awning. Press and hold the Awning Retract switch to retract the awning.

Limit switches in the electric actuators that extend and retract the sunshade will automatically stop the actuators when the sun shade reaches the fully extended or retracted positions.

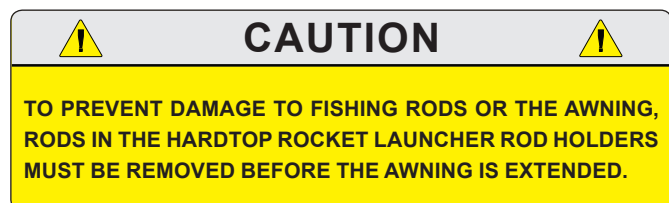

Additional DC Switches and Panels Trim Tab Switch Panel

Located in the helm. This switch panel controls the trim tab planes located on the transom of the boat. It is protected by a circuit breaker in the battery switch panel. Refer to the Helm Control Systems chapter for detailed information on the operation of the trim tab controls.

Engine Trim and Tilt Switches

Located in the helm. These switches are typically installed in the engine throttle and shift controls. They control the trimming and tilting of the engines. Refer to the Helm Control Systems chapter and the engine owner's manual for additional information and the proper use of the tilt and trim switches.

USB Connection

Typically located at the helm and in the bow seat area. Provides an input to charge devices that can connect to a USB port.

Head Control Panel

The electric head is controlled by switches in a panel located in the head compartment.

Power Ports (Optional)

The optional 12 volt power ports are located below the gunnel on each side of the cockpit. The power ports provide a 12 volt DC power connection for down riggers or electric reels. Each power port requires a special plug to be installed on the power cord of the accessory. Additional plugs can be ordered through your dealer.

The ports are protected by individual circuit breakers located inside the leaning post next to the engine batteries.

Phone Charging Station

A cell phone pad and inductive charger is located on top of the center console. The pad secures and charges any phone with an inductive charging feature.

Electronics Main Bypass Switch

A heavy duty switch that provides emergency electrical power from the batteries directly to the electronic navigation screens. It is located below the helm behind the hinged access panel in the rear head compartment bulkhead.

In the unlikely event of a power failure of the helm circuits while offshore, this switch can be activated to bypass all circuit distribution panels and circuit protection to activate the electronics for navigation.



Head Control Panel



Phone Charging Station



Electronics Main Bypass Switch

Electrical System



Accessory & Main Circuit Breakers In Battery Switch Panel

A. Accessory "Push To Reset" Circuit Breakers

B. Heavy Duty Circuit Breakers

6.7 DC Circuit Breakers

General

Power is distributed to some 12 volt accessories through individual "push to reset" circuit breakers located the battery switch panel. A heavy duty breaker near the battery switches protects the system from an overload. Other heavy duty circuit breakers near the battery switches protect the main circuits for the windlass, optional air conditioner, optional refrigerator and stereo amplifiers.

Some 12 volt accessories are operated directly by the circuit breaker or fuse. Switches fed by the circuit breakers or fuses activate other accessories.

Accessory Circuit Breakers

These "push to reset" circuit breakers are labeled for the accessory circuit they protect. Circuit breakers labeled ACC are reserved for additional accessories not usually installed by the factory.

If an accessory breaker trips, the reset button pops out and can be felt through the silicone protective cover. Press the button to reset the tripped breaker. If the breaker trips again, find and correct the problem before resetting the breaker.

Notice:

The bilge pump and high water alarm breakers protect continuous power circuits for the automatic switches. Continuous power circuits are supplied electrical power whenever the batteries are connected. These circuits are not deactivated when the battery switches are turned off.

CAUTION

PROPER FUSE OR BREAKER PROTECTION MUST BE PROVIDED FOR ALL 12 VOLT EQUIPMENT ADDED. DO NOT OVERLOAD THE ACCESSORY CIRCUIT BREAKERS OR OTHER CIRCUITRY THROUGH ADDITIONAL 12 VOLT EQUIPMENT.

Heavy Duty Circuit Breakers

DC Power is distributed to the accessory breakers, Digital switching system, windlass and other main circuits through heavy duty, rocker style circuit breakers located in the battery switch panel near the battery switches. These main circuits are deactivated when the House battery switch is off.

If a heavy duty circuit breaker is tripped by an overload, the breaker will trip. Reset the breaker by turning it off, then back on.

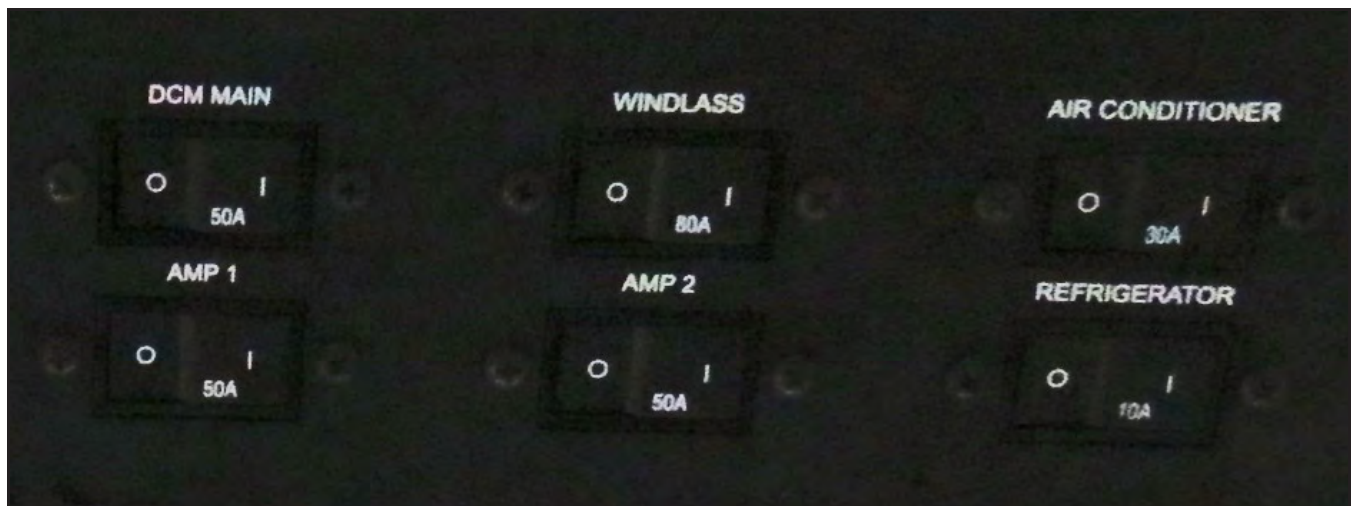

Typical Heavy Duty Circuit Breakers

Notice:

If a heavy duty circuit breaker trips, always make sure the problem that caused the breaker to trip is found and corrected before resetting the breaker.

6.8 Engine Control Systems Circuit Protection

Power assist steering and Yamaha or Mercury engines with electronic steering and control systems are equipped with heavy duty circuit breakers or fuses for each steering pump and the controls that protect those components from an overload. Other heavy duty circuit breakers or fuses protect the auxiliary charging circuit for each engine.

Circuit protection will vary with each engine installation as controls and steering systems may be different. Refer to the engine and steering system owner's manuals for information on circuit protection and amperage requirements for the engines and control systems on your boat.

6.9 Accessory Fuse Panels

Fuses in panels located below the helm protect the circuits for other accessories not protected by the accessory circuit breakers or fuses in the digital switching control module. The fuse panels are supplied power by the Main circuit breaker or are continuous power, depending on the circuit they protect.

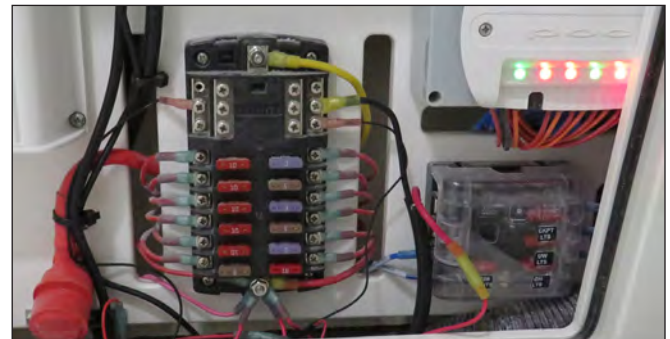

Typical Fuse Panels Below the Helm

Notice:

Continuous power circuits are supplied electrical power whenever the batteries are connected. These circuits are not deactivated when the battery switches are turned off.

Each fuse is labeled by the circuit of the accessory they protect. The fuses in your boat will vary, depending on the equipment and optional equipment selected.

If a fuse blows, it must be replaced with a fuse of the same amperage as the original. The fuses are labeled and color coded. Never try to correct a problem with a 12 volt accessory by installing a larger fuse. This could cause the accessory or circuit with a problem to overheat, which could result in an electrical fire.

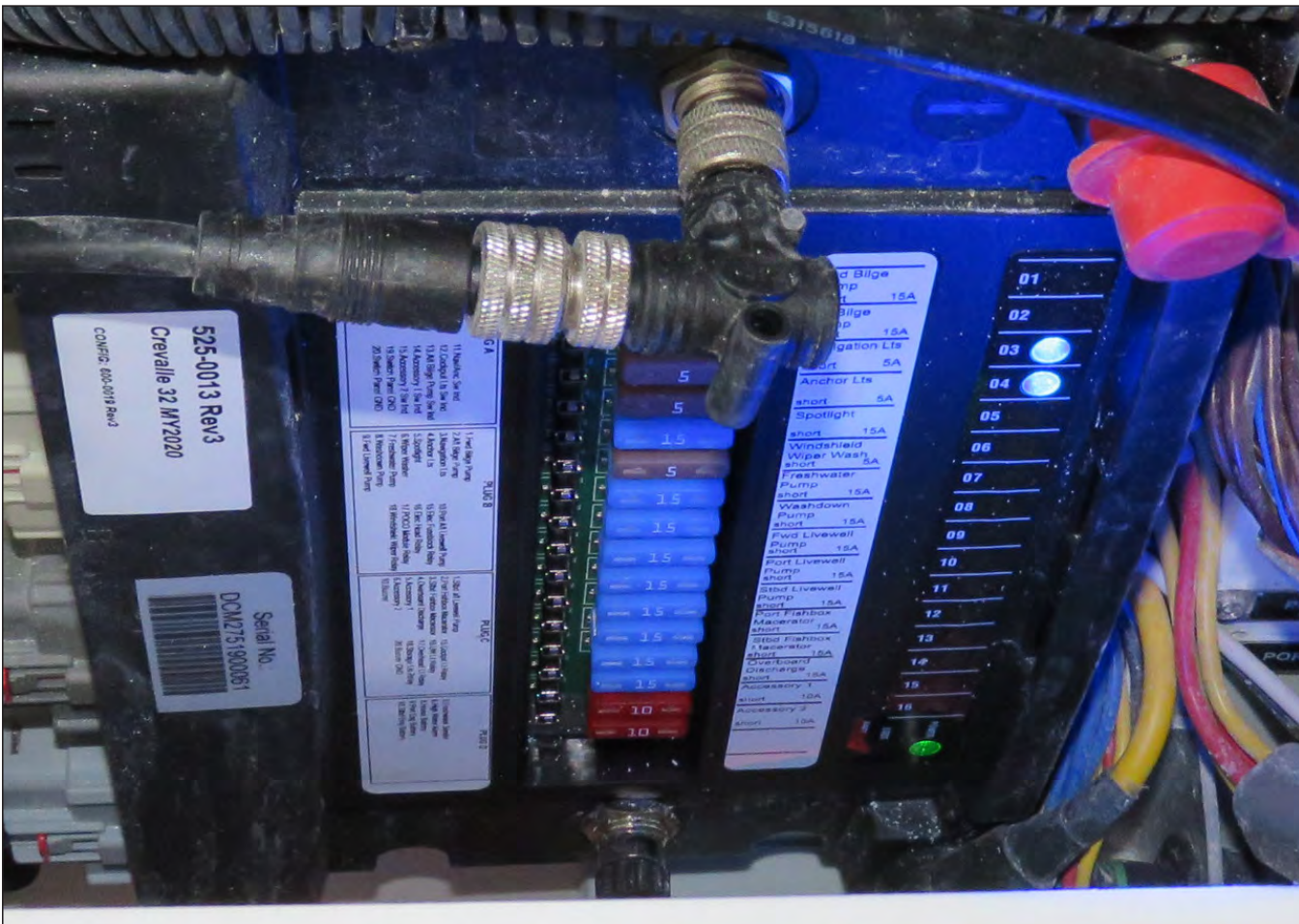

Digital Switching Control Module

6.10 Digital Switching System Circuit Protection

Accessories circuits activated by the digital switches in the helm and electronics touch screens are protected by spade type fuses located in the control module below the helm. The control module and fuse panel is accessed through a hinged hatch in the head compartment rear bulkhead.

The fuses are color coded to indicate the amperage of the fuse. The amperage rating is also clearly printed on the fuse housing and the labels on the

power management module. Never replace a blown fuse with a fuse of a higher amperage and/or a different color.

In the unlikely event of a switch failure, the fuse can be moved to the bypass position. Simply remove the fuse from the normal fuse holder and place it into the bypass position. The corresponding circuit will now be on for as long as the fuse is in that position and no longer be controlled from the switch panel or touch screen. When the problem is corrected, move the fuse back to the original position for normal operation.

6.11 36 volt Trolling Motor System

If your boat is equipped with the optional trolling motor, it will also be equipped with a 36 volt DC electrical system that provides power to the trolling motor. The 36 volt system consists of three 12 volt, deep cycle batteries wired in series, a three bank battery charger and circuit protection. A heavy duty outlet plug with a protective cover is installed near the bow that provides the connection for the trolling motor. The system is completely isolated from the boat 12 volt engine and accessory circuits. A heavy duty circuit breaker located near the battery switch protects the circuit from an overload and a three bank battery charger recharges the batteries whenever the boat is plugged into shore power.

The trolling motor batteries are located in the forward bilge storage compartment in the bow. The circuit breaker is located in the battery switch panel below the helm.

Make sure the trolling motor batteries are fully charged and the main circuit breaker is activated before using the trolling motor. The trolling motor will not operate properly if the batteries are low. Always remember to turn the trolling motor circuit breaker on before using the trolling motor and off when the system is not in use.

An owners manual is included with the trolling motor. It is essential that you read the manual and be completely familiar with the operation of the trolling motor, controls and mounting brackets before using the trolling motor on your boat.



Typical Trolling Motor



Trolling Motor Connection Panel In Bow



WARNING



DO NOT USE A BATTERY EQUALIZER OR OTHER DEVICE THAT WILL CONNECT THE ENGINE AND HOUSE BATTERIES TO THE TROLLING MOTOR BATTERIES. IN SOME SITUATIONS, THESE DEVICES CAN CAUSE THE BATTERY CHARGER TO OVERCHARGE THE BATTERIES WHICH WILL RESULT IN THE RELEASE OF DANGEROUS HYDROGEN GAS.

HYDROGEN GAS WILL CORRODE METAL HARDWARE NEAR THE BATTERIES AND CAN CAUSE AN EXPLOSION. A BATTERY CAN EXPLODE IF A FLAME OR SPARK IGNITES THE HYDROGEN GAS THE BATTERY EMITS WHILE BEING CHARGED. THIS CONDITION IS PARTICULARLY DANGEROUS WHEN BATTERIES ARE BEING OVERCHARGED.

Electrical System

6.12 DC Power Management

Large modern outboard powered boats are typically equipped with a full array of electronics, fuel injected engines, stereo amplifier, DC air conditioning systems, spreader lights and other accessories that consume a significant amount of DC electrical power. All outboard engine charging systems are designed to provide maximum electrical output at or above cruising RPM. The electrical output from the charging system is considerably less at idle or trolling speeds.

Depending on the optional equipment and electronics installed on your boat, there may be times when the charging systems on your engines will not be able to meet the DC electrical power demand if too many accessories are activated while the boat is operating at idle or trolling speeds. Consequently, POWER MANAGEMENT PRACTICES may need to be observed at slow speeds, particularly if your boat is equipped with a full electronics package and the optional DC helm air conditioning system.

The house battery system in your boat is designed to provide several hours of reserve capacity, which is adequate for most situations. However, you should be aware of the load each of your DC accessories draw and make sure you don't overload

the capacity of the charging system for extended periods while operating the boat below cruising speed. Always monitor the volt meters while operating at slow speeds and turn off unnecessary equipment that draw high amperage loads if the volt meters indicate that the voltage in the batteries is below 12.3 volts. If necessary, reduce the electrical load by turning off or alternating the use of high draw DC accessories such as the DC air conditioner, radar units, stereo, spreader lights, etc.

If the house battery system that powers the electronics and accessories on your boat becomes critically discharged while underway at low speeds or trolling, make sure that you turn off all unnecessary DC equipment and run the boat engines at an RPM that will provide a reading of at least 13 volts on the volt meters to recharge the house batteries. Proper DC power management will prevent low voltage that can cause critical navigation equipment to become erratic or shutdown unexpectedly. Additionally, sound power management practices increase the life of your batteries and engine charging systems. You should contact your dealer if you have any questions regarding DC power management or the DC electrical system on your boat.

6.13 120 Volt Battery Charging System General

The battery charging system is supplied 120 volt AC current by a power cable connected to a shore side outlet and the shore power inlet. It is wired totally separate from the 12 volt DC system and charges the engine and house batteries simultaneously when connected.

Notice:

The power cord used for the battery charger system is not equipped with lock rings on the shore side or boat connector plugs. The charger has integrated reverse polarity protection and the circuit is not equipped with a reverse polarity light.



Typical Shore Power Inlet Connection

⚠ **DANGER** ⚠

TO REDUCE THE POSSIBILITY OF AN ELECTRICAL SHOCK, IT IS IMPORTANT THAT THE AC GROUND SYSTEM IS FUNCTIONING PROPERLY AND THAT A PROPER CONNECTION EXISTS BETWEEN THE SHORE POWER CORD AND THE SHORE POWER INLET AND THE OUTLET GROUND CIRCUITS. IF THERE IS ANY DOUBT ABOUT THE INTEGRITY OF THE GROUND CIRCUIT, A QUALIFIED MARINE ELECTRICIAN SHOULD BE CONTACTED IMMEDIATELY AND THE SHORE POWER SHOULD BE DISCONNECTED UNTIL THE NECESSARY REPAIRS ARE COMPLETED.

ELECTRICAL SHOCKS FROM 120 VOLT CIRCUITS CAN CAUSE SEVERE INJURY OR DEATH. TO REDUCE THE RISK OF ELECTRICAL SHOCK IN WET WEATHER, AVOID MAKING CONTACT WITH THE SHORE CABLE OR MAKING A CONNECTION TO A LIVE SHORE OUTLET. NEVER SPRAY WATER ON ELECTRICAL CABLES WHILE WASHING DOWN DECKS.

your dealer or a qualified electrician to find and correct the problem.

⚠ **WARNING** ⚠

DO NOT ATTEMPT TO CORRECT THE WIRING YOURSELF. ELECTRIC SHOCK CAN CAUSE SEVERE INJURY OR EVEN DEATH. ALWAYS HAVE A QUALIFIED ELECTRICIAN CHECK WIRING.

KEEP CHILDREN AWAY FROM ANY ELECTRICAL CABLES OR EQUIPMENT.

Procedure For Making A Shore Connection

If the dockside outlet includes a circuit breaker, turn it to the OFF position. To avoid strain on the cable, make sure it has more slack than the mooring lines. Dress the cable so that it cannot be damaged by chafing between the boat and the dock. Make sure the cable does not come in contact with the water.

The shore power inlet plug is located on the starboard side of the helm seat base. Open the cover on the inlet and connect the shore cable to the plug making sure the shore cable includes a three-prong plug with a ground wire. Turn the dockside circuit breaker on and check that the battery charger is operating properly. If the battery charger is not working, turn off the shore circuit breaker and remove the cable. Contact

⚠ **WARNING** ⚠

UNDETECTED FAULTS IN THE AC BATTERY CHARGING SYSTEM COULD CAUSE THE WATER AROUND THE BOAT TO BECOME ENERGIZED. THIS COULD CAUSE A SEVERE SHOCK OR EVEN DEATH TO SOMEONE IN THE WATER NEAR THE BOAT. NEVER SWIM OR ALLOW SWIMMING AROUND THE BOAT WHEN THE BATTERY CHARGING SYSTEM IS ACTIVATED BY THE SHORE POWER CONNECTION.

Procedure For Disconnecting A Shore Connection

Turn the circuit breaker on the dockside outlet to the OFF position. Disconnect the cable from the dockside outlet and replace the outlet cap. Disconnect the cable from the inlet plug and close the cap. Store cable.

Electrical System



Typical Battery Charger

Battery Chargers

There are one or two battery chargers, depending on the options selected. The primary charger is a three bank charger for the engine and house batteries mounted in the battery compartment. There could also be a charger for the optional trolling motor batteries mounted in the forward storage compartment near the batteries.

AC electrical current is supplied directly to the battery chargers by the shore power cable. The chargers automatically charge and maintain the engine, house and/or trolling motor 12 volt batteries simultaneously when activated. Each charger is equipped with led lights to indicate the state of charge for each battery.

The charge to the engine batteries can be monitored by using the volt meters in the engine gauge cluster or the LED lights on the charger. To monitor the engine batteries with the volt meters in the engine gauge cluster, activate the charger and turn the engine battery switches on. Turn the ignition

key switch for each engine to the ON position (DO NOT START THE ENGINES) and read the voltage on the volt meter for each engine.

If the batteries are in good condition and charging properly, the volt meters will indicate between 12 and 14.5 volts. If the reading is below 12 volts, then the battery is not accepting a charge or the charger is not working properly. Always turn the ignition switches off immediately after monitoring is complete when using the voltmeters in the engine gauge cluster.

The wires that supply DC charging current to the batteries are protected by an internal fuse in the battery charger and external fuses, one for each battery output wire, located near each battery. The external fuses protect the DC charging circuit from the batteries to the charger. The internal fuses in the charger protect the DC charging circuit from the charger to the batteries. See the battery charger manual for more information.



6.14 Electrical System Maintenance

DC Electrical System Maintenance

At least once a year, spray all exposed electrical components behind the helm, in the stern bilge area and in the plugs with a protector. Removable light fixture bulbs should be removed and the metal contact areas coated with a non-water soluble lubricant like Teflon or Silicone grease. The sockets should be sprayed with a protector. Care must be taken not to get any oil or grease on the glass portion of the bulbs as this will cause the bulb to overheat and burn out.

Notice:

Most LED light fixtures are sealed and not serviceable.

 **CAUTION** 

WHEN REPLACING LIGHT BULBS IN MARINE LIGHT FIXTURES, ALWAYS USE A BULB WITH THE SAME RATING AS THE ORIGINAL. USING A DIFFERENT BULB COULD CAUSE THE FIXTURE TO OVERHEAT AND MELT OR SHORT CIRCUIT.

Check all below deck wiring to be sure it is properly supported, that the insulation is in good condition and that there are no loose or corroded terminals. Corroded terminals should be thoroughly cleaned with sandpaper or replaced, tightened securely and sprayed with a metal and electrical protector. Inspect all engine wiring.



Your boat is equipped with batteries that were supplied by the dealer. Some batteries are sealed, AGM or maintenance free wet cell batteries that do not require inspection or service. However, if your boat is equipped with standard wet cell type batteries that are not maintenance free, they will require the following inspection and service.

Check the electrolyte level in the batteries regularly and add distilled water as necessary. If the batteries are frequently charged by an automatic battery charger, the electrolyte level will have to be checked more often. The correct fluid level in the cells is approximately 1/4 to 1/2 inch above the plates. If fluid is needed, fill to the proper level with distilled water. Do not over fill and only use distilled water.

Keep all battery tops clean and dry. Dirt and water can conduct electricity from one post to the other causing the battery to discharge.

The battery posts on all batteries should be kept free of corrosion. Remove the cables and clean the

posts and cable clamps with a battery post cleaner or sandpaper as required. Coating the battery posts and cable clamps with Teflon or Silicone grease will protect them and reduce corrosion. Battery cables, both hot and ground, must be replaced when they show signs of corrosion or fraying. Deteriorated cables cause a considerable voltage loss when high currents are drawn, as for starting the engine.

 **WARNING** 



NEVER USE AN OPEN FLAME IN THE BATTERY STORAGE AREA. AVOID STRIKING SPARKS NEAR THE BATTERY. A BATTERY CAN EXPLODE IF A FLAME OR SPARK IGNITES THE HYDROGEN GAS THE BATTERY EMITS WHILE BEING CHARGED.

AC Electrical System Maintenance



Periodically inspect all wiring for nicks, chafing, brittleness, improper support, etc. Examine the shore power cord closely for cracks in the insulation and corrosion in electrical connectors. Spraying receptacles and electrical connections with an electrical contact cleaner or a metal and electrical protector will reduce corrosion and improve electrical continuity.

Inspect all wiring for proper support, sound insulation and tight terminals.

The entire AC circuitry, especially the shore power cord, should be seasonally tested for proper continuity by an experienced electrician. This will detect any shorts, open wires or ground faults.

 **WARNING** 

CORROSION ALLOWED TO BUILD ON THE ELECTRICAL CONNECTORS CAN CAUSE A POOR CONNECTION RESULTING IN SHORTS, GROUND FAULTS OR POOR GROUND CONNECTIONS. ELECTRICAL CONNECTORS SHOULD BE CHECKED AT LEAST ANNUALLY AND CLEANED AS REQUIRED. DO NOT ALLOW CORROSION TO BUILD ON CONNECTIONS.

 **WARNING** 

THE AC AND DC ELECTRICAL SYSTEMS ALWAYS SHOULD BE DISCONNECTED FROM THE POWER SOURCE BEFORE INSPECTING OR SERVICING THE SYSTEM. NEVER SERVICE ANY COMPONENT OF AN ELECTRICAL SYSTEM WHILE IT IS ENERGIZED.

NOTES

FRESH WATER SYSTEM

7.1 General

The fresh water system consists of a potable water tank, distribution lines and a distribution pump. The pump is equipped with an automatic pressure switch and is located in forward storage compartment and accessed via removable panel on forward bulkhead and accessed via removable panel on forward bulkhead in head compartment.

CAUTION

DO NOT FILL SYSTEM WITH ANYTHING OTHER THAN WATER. SHOULD THE SYSTEM BECOME CONTAMINATED WITH FUEL OR OTHER TOXIC FLUIDS, COMPONENT REPLACEMENT MAY BE NECESSARY.

WARNING

DO NOT CONFUSE FUEL FILL DECK PLATE WITH THE WATER OR WASTE FILL DECK PLATES. THESE PLATES ALSO ARE LABELED ACCORDINGLY. IF FUEL IS ACCIDENTALLY PUMPED INTO THE WATER OR WASTE TANK, DO NOT ATTEMPT TO PUMP IT OUT YOURSELF. WATER AND WASTE PUMPS ARE NOT DESIGNED TO PUMP FUEL AND A FIRE OR EXPLOSION COULD RESULT. CONTACT YOUR DEALER OR THE CREVALLE CUSTOMER SERVICE DEPARTMENT FOR ASSISTANCE IN HAVING THE FUEL PROFESSIONALLY REMOVED AND COMPONENTS OF THE FRESH WATER SYSTEM REPLACED AS NECESSARY.



Typical Fresh Water Fill



Fresh Water Pump & Strainer

7.2 Fresh Water System Operation

Fill the water tank slowly through the labeled deck fill fitting. After filling the tank, activate the Fresh Water Pump switch in the helm switch panel and open the valves on the fresh water sink faucets overhead shower. Allow the pump to run until all of the air is purged from the system and a steady stream of water is flowing from each faucet or spray head. Close the valve to stop the water flow. As the pressure builds the pump will automatically shut off.

When properly primed and activated, the water system will operate much like the water system in a home. An automatic pressure sensor keeps the system pressurized. If the system has been recently filled or has not been used for an extended period, air bubbles may accumulate at the pump and the system may have to be reprimed.

Whenever the boat is left unattended, the Fresh Water Pump switch should be placed in the OFF position.

CAUTION

DO NOT ALLOW THE FRESH WATER PUMP TO RUN DRY. THE FRESH WATER PUMP WORKS ON DEMAND AND WILL NOT SHUT OFF AUTOMATICALLY WHEN THE TANK IS EMPTY. THIS CAN RESULT IN DAMAGE TO THE PUMP. ALWAYS TURN THE FRESH WATER SWITCH OFF WHEN THE SYSTEM IS NOT IN USE.

Fresh Water System

Fresh Water Sinks & Shower

There is a shower spray head located in the head compartment sink and on the starboard side of the hardtop liner. Each shower has cold water and an on/off valve. The head compartment sink has a retractable shower head that pulls out and mounts to a wall bracket to convert the sink to a shower.

To use the hardtop shower, make sure the Fresh Water Pump switch is on. Then open the ladder and fire extinguisher compartment door and turn on the control valve to supply water to the shower head. Turn the valve off when showering is complete.

To use the shower in the head compartment, make sure the Fresh Water Pump switch is on. Pull the spray head out of the fitting on the sink and mount it to the wall bracket. Turn the sink faucet valve on and activate the valve on the spray head. To conserve water, use the valve on the spray head to turn the water on and off as you use it.

Shower water is drained from the head compartment by a drain in the floor and the forward bilge pump.

Aft Work Station Sink

The fresh water sink in the aft work station sink is supplied by the fresh water system. To use the sink, open the hatch. Then rotate the faucet to the operating position and make sure the Fresh Water Switch is on. The faucet works like faucets in your home when the fresh water system is activated. Always lower the faucet to the stored position and close the lid when the sink is not being used.



Hardtop Shower



Hardtop Shower Control Valve

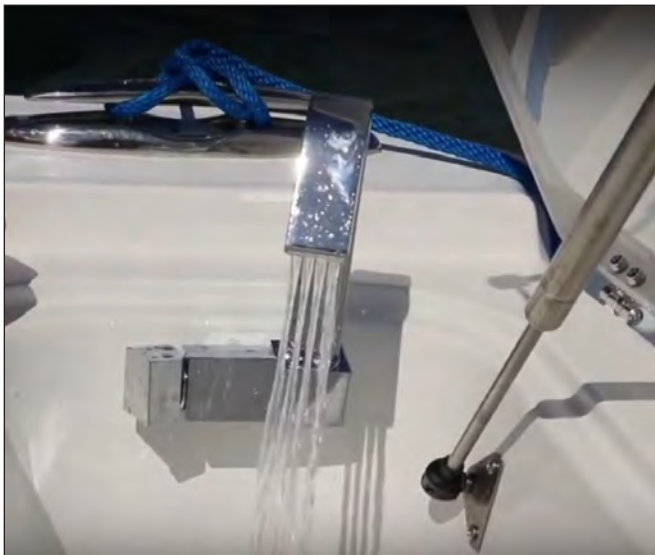

Aft Work Station Sink



Head Compartment Sink & Shower Spray Head

7.3 Fresh Water System Maintenance

Information supplied with water system components by the equipment manufacturers is included with this manual. Refer to this information for additional operation and service data.

The following items should be done routinely to maintain your fresh water system:

- Periodically remove and clean the water strainer located at the intake side of the pressure pump. To clean the strainer, make sure the Fresh Water Pump switch is off. Rotate the strainer bowl counterclockwise to release it. Remove and clean the screen with fresh water. Lubricate the O-ring lightly with Teflon or silicon grease and reinstall the screen and strainer bowl.
- Periodically spray the pump and metal components with a metal protector.
- The batteries must be properly maintained and charged. Operating the pressure pump from a battery with a low charge could lead to pump failure.
- Add a commercially available potable water conditioner to the water tank to keep it fresh.

Sanitizing the Fresh Water Tank

The freshwater system should be sanitized if it has not been used for a long period or you are unsure of the quality of the water in the system.

The following steps can be used to sanitize the system:

- Activate the system and pump out as much water as you can.
- Make a chlorine solution by mixing two ounces of household chlorine bleach in a gallon of water. This mixture will treat approximately fifteen gallons. If the water tank on your boat is larger or smaller than 15 gallons, then adjust the mixture accordingly. Always mix the chlorine with water in a separate container first and never add straight chlorine to the fresh water tank.
- Fill the water tank half full with freshwater and pour the mixture into the water tank. Top off the tank.
- Activate the system and allow the water to run from the washdown hose for about 1 minute. Let the treated water stand for 4-6 hours.
- Drain the system by pumping it dry and flush with several tank fills of freshwater.
- The system should now be sanitized and can be filled with freshwater. If the chlorine smell is still strong, it should be flushed several more times with freshwater.



Typical Fresh Water Pump & Strainer

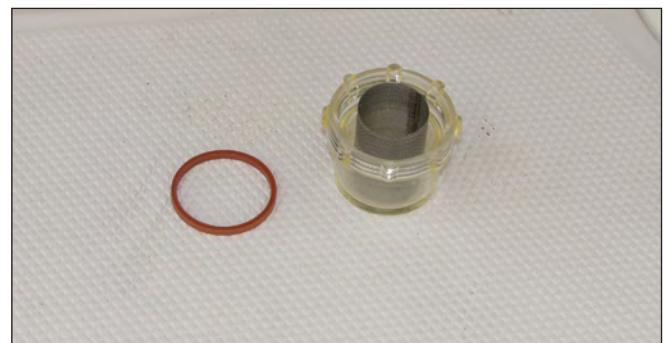

Typical Fresh Water Pump Strainer Removed for Cleaning



CAUTION



THE FRESH WATER SYSTEM MUST BE PROPERLY WINTERIZED PRIOR TO WINTER LAY-UP. SEE SECTION ON WINTERIZING.

NOTES

Chapter 8: RAW WATER SYSTEM

8.1 General

The livewell seawater pumps are mounted to a sea chest located in the aft systems compartment bilge. Two intake thru-hull fittings for the sea chest are equipped with ball valves to turn the raw water supply to the sea chest on or off. A strainer built into the primary intake supply fitting filters debris as seawater flows to the sea chest. The strainer should be checked frequently and cleaned as necessary.

The raw water washdown pressure pump is mounted in the aft system compartment and is also connected to the sea chest. Always make sure all valves are open before attempting to operate any component of the raw water system.

8.2 Priming the System

Open all sea chest intake valves. The sea chest is vented to a thru-hull fitting in the hull side to automatically purge air from the sea chest as it fills.

Make sure the Wash Pump switch in the helm switch panel is on. Run the pressure pump by turning on the Wash Pump switch and activating washdown spray nozzle valve until all of the air is purged from the system, then turn the valve off.

Activate the livewell pump switches and run the pumps until all of the air is purged from the system. Then turn the pumps off.

The primary sea chest water intake fitting is equipped with a scoop that supplies pressurized water to the sea chest and helps prime the system while the boat is underway during normal operation. If a pump runs but will not prime, make sure the sea chest valves are open. If the pump still won't prime, it may be air locked. Make sure the sea chest intake valves are open and run the boat at or above 15 MPH. Water pressure from the sea chest will usually force trapped air through the pump and allow it to prime. If this procedure doesn't work, contact your Crevalle dealer.



Sea Chest & Livewell Pumps



Raw Water Pump & Strainer

Closing the sea chest intake thru-hull valves before the boat is hauled from the water will help to eliminate air locks in the livewell seawater system. The valves should also be closed whenever you leave the boat in the water unattended.

Notice:

It may be necessary to reprime the raw water system if it is not used for an extended period and at the time of launching.

Raw Water System

8.3 Raw Water System Operation

A high pressure pump, controlled by a pressure sensor, is activated by the Wash Pump switch in the helm switch panel. When activated, the pressure switch will automatically control the pump that supplies the raw water hose spray nozzle.

As the pressure builds in the system, the pump will shut off. When the system is in use and the pressure drops, the pump will turn on. The water system is equipped with a strainer on the intake side of the pump. The strainer should be checked frequently and cleaned as necessary.

Whenever the boat is left unattended, the Wash Pump switch should be placed in the OFF position.

Washdown Hose & Spray Nozzle

A raw water washdown hose & nozzle is located on the starboard side of the cockpit in the side ladder and fire extinguisher storage compartment. The nozzle is connected to a hose on an spring loaded, automatic retracting reel.



To use the washdown hose, make sure the Wash Pump switch in the helm switch panel is on. Pull the spray nozzle and hose out of the receptacle until the desired length of hose is deployed. Pull the hose out slowly until the reel clicks, then allow the hose to retract slightly until the reel locks. Activate the nozzle valve to spray water.

When washdown operations are complete, pull the hose out slightly until the reel clicks to release the lock and allow the reel to retract the hose. Keep tension on the hose as it retracts to prevent tangles or kinks in the hose on the reel. Seat the nozzle in the storage compartment recess. If the hose kinks or tangles as it retracts, pull the hose out and start over.



Washdown Hose & Spray Nozzle

When the hose is fully retracted, make sure to turn the Wash Pump switch is turned off.

	CAUTION	
DO NOT ALLOW THE WATER PUMP TO RUN DRY. THE PUMP WORKS ON DEMAND AND WILL NOT SHUT OFF AUTOMATICALLY IF NO WATER IS AVAILABLE. THIS CAN RESULT IN DAMAGE TO THE PUMP. ALWAYS TURN THE RAW WATER SWITCH OFF WHEN THE RAW WATER SYSTEM IS NOT IN USE.		

8.4 Livewells

Seawater is provided to each livewell by 12 volt circulation pumps. The pumps are designed to carry a constant flow of water to the livewells. The pumps do not have a pressure sensor and are activated by the livewell pump switches in the helm switch panel. There are also lights in the livewells that are activated by the livewell lights switch.

Adjustable supply and overflow valves in the side of the livewell automatically control water flow and level. Always turn the pump off when a livewell is not in use. On the rear livewells, the supply and overflow valves can be used to slightly pressurize the wells for more lively bait. The forward livewell below the lounge seat is not intended to be pressurized.

To fill a livewell, insert the drain plug into the fitting at the bottom of the livewell. Make sure the valves at the sea chest and the supply valve in the livewell are open. Then activate the livewell pump. When the water level reaches the desired level, it will begin to circulate. Adjust the overflow and supply valves as necessary to achieve the desired level or pressure and flow.

The sea chest primary intake fitting is equipped with a high speed pickup that will supply pressurized water to the livewell if the pump should fail and helps prime the system during normal operation. To supply water to the livewell using the high speed pickup, make sure the sea chest intake valves are open and run the boat at a speed above 15 miles per hour. Pressurized water from the sea chest will circulate through the livewell and out the overflow.

To drain the livewell, turn off the livewell pump and remove the drain plug. When the livewell has completely drained, use the washdown hose to flush the livewell and drain of debris.

The livewell supply valves at the sea chest should be closed whenever the livewell is not in use. This will prevent water from entering the livewells while the boat is cruising.

Notice:



Do not use a livewell as a dry storage area when it is not in use. Seawater could accidentally be delivered to the livewell from the thru-hull fitting and damage equipment stored there.



Front Livewell



Aft Livewell Drain Fitting, Light & Overflow/Fill Valves

	CAUTION	
A RUPTURED RAW WATER INTAKE OR PRESSURE LINE COULD CAUSE THE BOAT TO TAKE ON WATER AND SINK. ALWAYS TURN THE RAW WATER SYSTEMS OFF AND CLOSE THE THRU-VALVES WHEN LEAVING THE BOAT UNATTENDED.		

Raw Water System

8.5 Raw Water System Maintenance

The following items should be done routinely to help maintain your raw water system:

- Check hoses, particularly the seawater supply lines, for signs of deterioration. Tighten fittings or replace deteriorated hoses and components as necessary.
- Periodically remove and clean the water strainer located in the primary intake fitting for the sea chest.
- Periodically remove and clean the water strainer located near the intake side of the washdown pump. Spray pumps and thru-hull valves with a protective oil periodically.
- Fishboxes and livewells should be drained and cleaned after each use.
- Operate all valves at least once a month to keep them operating properly.

Cleaning the washdown pump water strainer:

1. To clean the strainer, make sure the Raw Water Pump switch is off and close the valves at the sea chest supply hose thru-hull fittings.
2. Rotate the strainer bowl counterclockwise to release it.
3. Remove and clean the screen with fresh water.
4. Lubricate the O-ring lightly with silicon or Teflon grease and reinstall the screen and strainer bowl.



Raw Water Pressure Pump & Sea Strainer

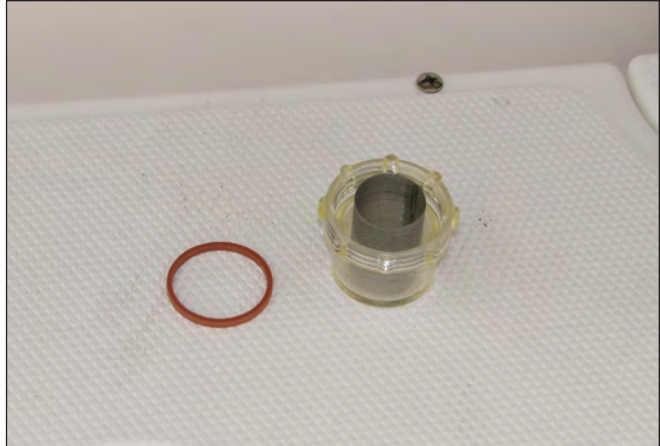

Typical Raw Water Pump Strainer Removed for Cleaning

Cleaning the Sea Chest Seawater Strainer

The primary supply hose fitting for the sea chest is equipped with a strainer that should be checked periodically and cleaned when necessary. It is built into the thru-hull fitting scoop and can be serviced when the boat is out of the water.

To clean the strainer:

1. Make sure all sea water pump switches are off.
2. Remove the set screw at the bottom of the scoop.
3. Slide the strainer screen down and out of the scoop.
4. Thoroughly flush the screen to remove foreign matter.
5. Reinsert the screen and secure it with the set screw.



CAUTION



SHOULD A HOSE RUPTURE, TURN THE PUMP OFF IMMEDIATELY. ALWAYS CLOSE THE THRU-HULL VALVE WHEN PERFORMING MAINTENANCE ON A SEAWATER PUMP.

THE BATTERIES MUST BE PROPERLY CHARGED. OPERATING ANY PUMPS FROM A BATTERY WITH A LOW CHARGE MAY LEAD TO A PUMP FAILURE.

THE RAW WATER SYSTEM MUST BE PROPERLY WINTERIZED PRIOR TO WINTER LAY-UP. SEE SECTION ON WINTERIZING.

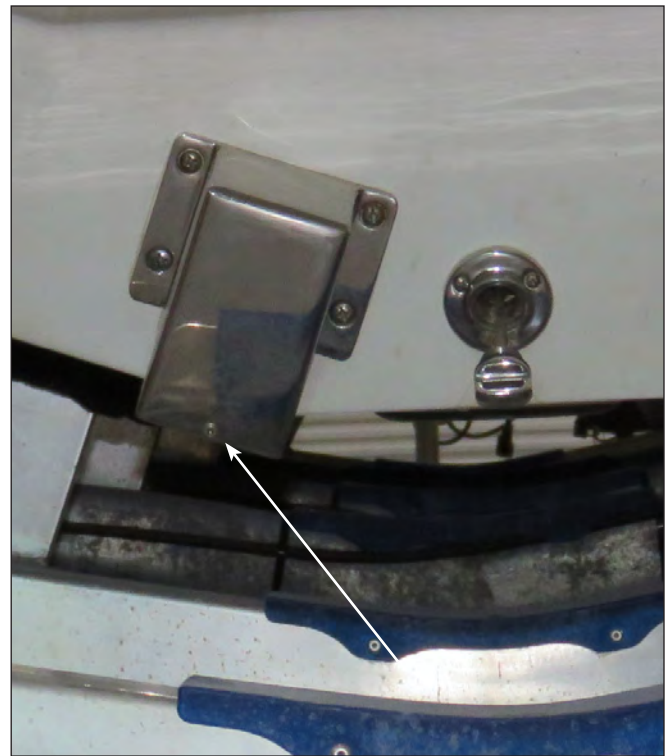

Sea Chest Intake Fitting Scoop & Strainer Set Screw

NOTES

9.1 General

All water is drained by gravity to overboard thru-hull fittings located in the hull above the water line. It is important to check the drain system frequently to ensure it is free flowing and that the hoses on the thru-hull fittings are secure and not leaking.

9.2 Cockpit & Deck Drainage

Cockpit Scupper Drains

Your boat has scupper drains located on each side of the rear cockpit below hinged stainless steel grates. They are designed to reduce the surge of seawater through the scuppers and into the cockpit while maneuvering or in rough water.

Water is channeled away from all hatches by a gutter or drain rail system. The water then drains overboard through the cockpit drain system.



Cockpit Scupper Drain

Aft Fishboxes

The fishboxes below the rear cockpit sole are drained by two diaphragm pumps, one for each fishbox, located in the aft systems compartment. The pumps are activated by switches in the helm and drain the boxes overboard through fittings in the hull sides above the waterline.

Monitor the water level as the pump drains the fishbox and turn it off immediately when draining is complete. The pumps could be damaged if they are allowed to run dry for extended periods.



Aft Fishbox Pumps

Aft Station Sink

The sink is drained by gravity to a thru-hull fitting in the hull side.

Aft Livewells

The livewells are drained by gravity to thru-hull fittings in the hull. The livewell overflows drain to the livewell drain system.

Forward Livewell

The livewell is drained by gravity to a thru-hull fitting in the hull. The livewell overflow drains to the livewell drain system.



Forward Livewell

Drainage Systems

Console Lounge Seat Storage Compartment

The storage compartment below the forward console lounge seat is drained overboard by gravity through a fitting in the hull side.

Forward Below Deck Storage Compartment

The forward storage compartment below the cockpit sole is drained by gravity to the forward bilge. The forward bilge is drained overboard by the forward bilge pump.

Bow Storage Compartments

The forward storage compartments below the port and starboard bow seats drain by gravity to the forward bilge.

Rope Locker

The rope locker drains overboard through a drain fitting in the hull at the bottom of the locker. It is important to inspect the drain frequently to remove any accumulated debris.

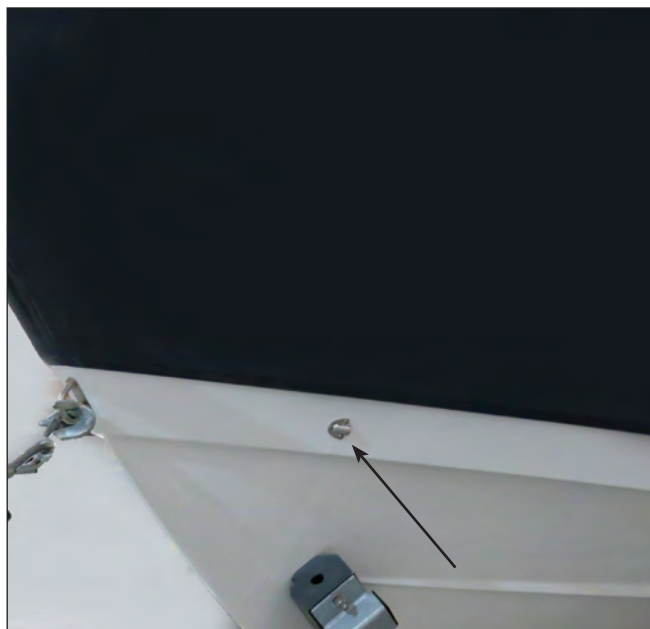

Anchor Rope Locker Drain

9.3 Bilge Drainage

There are three bilge pumps, aft, emergency, and forward. The aft and forward bilge pumps are activated both manually by switches in the helm station and automatically by float switches located near the pump. The automatic float switches are connected to the house battery bank. They are protected by "push to reset" circuit breakers in the battery switch panel and remain activated when the battery switches are in the OFF position and the batteries are connected. The manual switches are supplied current when the House battery switch is activated. They are protected by fuses in the digital switch control module.

All bilge pumps pump water out of thru-hulls located above the waterline in the hull sides. The aft bilge pump and automatic switch are located near the transom. The emergency bilge pump and switch are located on a shelf behind the aft bilge pump. The forward pump and automatic switch are located in the head compartment bilge.

The manual bilge pump switches should be activated briefly each time the boat is used. This will ensure that the pumps are operating properly and increase the service life of the pumps. The automatic switches should be manually activated periodically, by turning the test knob on the side of switches or flooding the bilge with a garden hose to verify operation. This is particularly important before operating the boat offshore.



Aft Bilge Pump & Automatic Switch

High Water Alarm and Emergency Bilge Pump

The automatic float switch for the emergency bilge pump is mounted above the normal operating range of the aft bilge pump automatic switch. It activates the pump and an alarm if the bilge water level rises above the normal operating range of the bilge pump automatic switches.

The alarm and emergency pump automatic switch is connected to the house battery bank. The circuits are protected by the High Water Bilge Pump and High Water Alarm "push to reset" breakers in the battery switch panel. It remains activated when the battery switches are in the OFF position and the batteries are connected.

Notice:

See Electrical Systems for additional information on bilge pump operation.

Garboard Drain Plug

When the boat is out of the water the bilge can be drained by a garboard drain located in the transom at the bottom of the hull. The plug should be removed whenever the boat is hauled out of the water and installed just prior to launching. It is important to check the drain plug regularly to make sure it is tight.



WARNING



A LOOSE DRAIN PLUG WILL ALLOW SEAWATER TO ENTER THE BILGE AND COULD CAUSE THE BOAT TO SINK. IT IS VERY IMPORTANT TO CHECK THE DRAIN PLUG FREQUENTLY TO ENSURE IT IS PROPERLY TIGHTENED.

Important:

Any oil spilled in the bilge must be thoroughly removed and properly disposed of before operating the bilge pump. The discharge of oil from the bilge is illegal and subject to a fine.



CAUTION



THE FEDERAL WATER POLLUTION CONTROL ACT PROHIBITS THE DISCHARGE OF OIL OR OILY WASTE INTO OR UPON THE NAVIGABLE WATERS OF THE UNITED STATES OR THE WATERS OF THE CONTIGUOUS ZONE IF SUCH DISCHARGE CAUSES A FILM OR SHEEN UPON OR A DISCOLORATION OF THE SURFACE OF THE WATER OR CAUSES A SLUDGE OR EMULSION BENEATH THE SURFACE OF THE WATER. VIOLATORS ARE SUBJECT TO A PENALTY OF \$10,000.



Emergency Bilge Pump & Emergency Pump & Alarm Automatic Switch



Forward Bilge Pump & Automatic Switch



Transom Garboard Drain Plug

Drainage Systems

9.4 Hardtop Drains

There is a hole drilled in the leg bases on hardtop frame to prevent water from being trapped within the legs. Additional drain holes are drilled in the tubing to drain other areas as required.

Always make sure the drain holes are clear when the boat is laid up for the winter. Water trapped inside the legs and frame could freeze and cause the legs to split.

9.5 Head Compartment Drains

The head compartment sole drains to the forward bilge through rod holder/grates in the center front and rear sole. The head compartment and forward bilge is drained overboard by the forward bilge pump which is mounted in the head compartment bilge.

9.6 Drainage System Maintenance

It is essential that the following items be done periodically to maintain proper drainage of your boat:

- Clean the cockpit drain rails with a hose to remove debris that can block water drainage.
- Clean the hardtop leg drain holes. This is especially important just before winter lay-up.
- Clean the bilge pump strainers of debris and check the bilge for foreign material that can cause the pump or automatic switch to malfunction.
- Frequently test the automatic bilge pump switches for proper operation. This is accomplished by turning the knob on the side of the float switch until the pump is activated. The pumps can also be activated by flooding the bilge with a garden hose until they activate.
- Frequently test the emergency pump and alarm automatic float switch. This is accomplished by rotating the knob on the side of the float switch until the pump and alarm are activated.
- Flush all gravity drains with fresh water to keep them clean and free flowing.



Automatic Switch Test Knob



Head Compartment Rod Holder/Drain

- Clean and flush fishboxes, coolers and storage boxes with soap or a bilge cleaner and fresh water after each use to keep them clean and fresh.

Note: All drains and pumps must be properly winterized before winter lay-up.

CAUTION



NEVER USE HARSH CHEMICAL DRAIN CLEANERS IN MARINE DRAIN SYSTEMS. PERMANENT DAMAGE TO THE HOSES AND FITTINGS MAY RESULT.

10.1 Head Compartment Ventilation Cabin Door

Ventilation to the cabin is provided by opening the cabin door and windows. The cabin door is located in the port side of the center console.

Before using the head in hot weather, it is best to open the door for several minutes to provide maximum ventilation and cool the head compartment as much as possible.

Make sure the door is closed and secured with the latch when the head compartment is not being used and before operating the boat above idle speed.

	CAUTION	
NEVER LEAVE THE CABIN DOOR UNLATCHED. THE CABIN DOOR IS HEAVY AND CLOSES EASILY. IF THE DOOR IS LEFT UNLATCHED, IT COULD SLAM UNEXPECTEDLY AS THE BOAT ROCKS, DAMAGING THE DOOR OR CAUSING AN INJURY TO A PASSENGER. ALWAYS MAKE SURE THE DOOR IS PROPERLY LATCHED IN THE CLOSED POSITION WHEN THE HEAD COMPARTMENT IS NOT BEING USED.		



Head Compartment Door & Latch

Port Window

An opening port window is located in the door and on starboard side of the head compartment. The port windows are equipped with a screen and secured in the closed position with twist action locks. The locks should be adjusted so they are tight enough to seal the window in the closed position, but not so tight that they break the plastic.

Always make sure the windows are closed and secured with the cam levers whenever the boat is underway. Sea spray could enter the head compartment through the open windows and damage equipment or items stowed there.



Cabin Port Window & Twist Action Locks

Ventilation System



Windshield Vent Extend/Retract Switches

10.2 Windshield Ventilation

Ventilation through the windshield is provided by a power actuated opening panel at the top of the windshield. The vent panel is opened and closed by an electric actuator controlled by the Vent Extend/Vent Retract switches in the helm switch panel. To open the vent, press hold the Vent Extend switch and open the panel to the desired position. To close the panel, press and hold the Vent Retract switch until the panel is completely closed.

A limit switch in the actuator will automatically stop the actuator when it reaches the full open or closed position to prevent damage to the windshield or the actuator. The switches automatically return to the off position when they are released.

10.3 Maintenance

- Periodically lubricate all hinges and latch assemblies with a light oil.
- Periodically clean and coat gasket materials with silicone to help keep them pliable.



11.1 Deck Rails & Deck Hardware

The rail system and hardware fittings have been selected and installed to perform specific functions. Hand rails are installed to provide a handhold in certain areas of the boat. You should make sure you keep at least one hand on the handholds as you move about the boat.

The cleats on your boat are retractable and flush with the deck when not in use. To use the cleats, pull up on the center of the cleat until it locks in the mooring position.

Fenders or mooring lines should be secured to the cleats and not to rails or stanchions. Be sure a clear lead exists when running dock lines or anchor lines. A line inadvertently run around a stanchion or over the rail could cause damage.

Important:



All fittings must be periodically inspected for loose fit, wear or damage. Any problems should be corrected immediately.



Cleat Up



Cleat Retracted

	WARNING	
CREVALLE BOATS ARE NOT EQUIPPED WITH HARDWARE DESIGNED FOR TOWING PURPOSES. THE MOORING CLEATS ARE NOT TO BE USED FOR TOWING ANOTHER VESSEL OR HAVING THIS BOAT TOWED.		



Anchor Rope Locker Hatch

11.2 Anchor & Rope Locker

The anchor rope locker is concealed in a recess below a hatch in the deck. A friction springs hold the hatch in the open position. A flush, twist lock latch secures the hatch in the closed position. Always make sure that the hatch is closed and latched before operating the boat above idle speed.

The rope locker and anchor line is accessed through an opening on the port side of the compartment. The anchor line is always stored in the rope locker and there is an eye fitting to secure the bitter end of the anchor line. A notch in the hatch allows it to be closed when the line is routed out of the locker and secured to a bow cleat. To avoid damage to the anchor line, make sure the line is aligned with the notch before closing the hatch.

The rope locker is designed for the anchor line and not for storing anchors or additional anchor lines. Do not store anchors or any heavy objects in the locker. Anchors and weights for floating markers will bounce and damage the hull or rope locker if they are stored there. They will also interfere

with deploying the anchor line or the operation of the windlass. Always store and secure additional anchors and weights in a storage compartment in the cockpit, as far aft as possible.

The rope locker is drained by a thru-hull fitting in the hull side near the bottom of the locker. It is very important to check the drain frequently to make sure it is clean and free flowing.

Periodically remove the anchor line from the rope locker, rinse it with fresh water and allow it to dry in the sun. Cleaning the anchor line regularly will reduce odors in the rope locker and increase the life of the line.

The line should also be inspected for abrasions or signs of deterioration. Replace the line if it shows any sign of damage or deterioration. If your boat is equipped with a windlass, it is important to replace the anchor line with a new line of the type recommended or supplied by the windlass manufacturer.

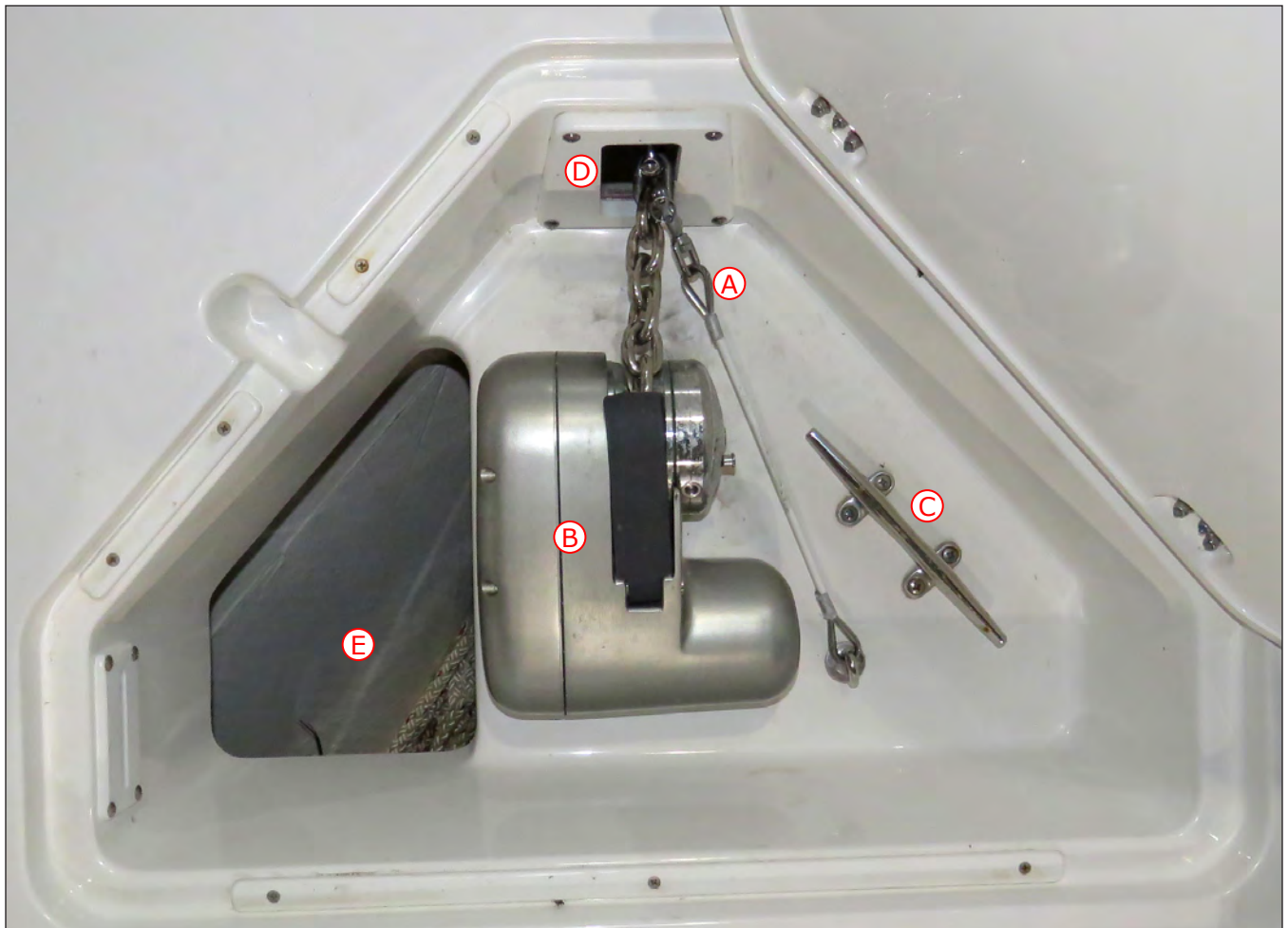

Windlass Compartment

A. Chain Binder

B. Windlass

C. Anchor Line Cleat

D. Bow Roller Assembly

E. Rope Locker

11.3 Windlass & Bow Roller

Bow Roller

The bow roller is built into the hull and equipped with hardware that allows the anchor to be operated and stored at the roller. The roller assembly, anchor line and chain binder are concealed below a hatch in the deck. The anchor line is stored in the rope locker and routed out through the windlass and connected to the anchor chain. A chain binder is provided to secure the anchor. Always make sure the anchor is properly secured by the chain binder when it is in the stored position on the roller.

The chain binder is accessed by opening the hatch and is designed to connect to a link in the anchor chain when the anchor is hauled in. To release the

binder, pull the anchor chain in slightly to relieve the tension on the binder, then release the binder from the chain. To secure the anchor in the up and stored position, raise the anchor until it seats firmly in the roller with the chain snug. Attach the chain binder to a link in the chain. Before getting underway after hauling the anchor, always make sure the binder is properly attached to the anchor chain link and the hatch is closed and latched.

Windlass

The windlass is mounted in the compartment below the hatch in the deck. The anchor is stored on the roller and raised and lowered by the windlass. The anchor line is stored in the rope locker and routed out through the windlass to the anchor chain.

Exterior Equipment

The anchor is lowered by releasing the anchor chain from the chain binder and pressing the Windlass Down switch at the helm. The windlass control switches are protected by a circuit breaker in the battery switch panel.

After the anchor is set, the windlass must not be left to take the entire force from the anchor line. Boats lying to their anchor in a high swell or heavy weather conditions will snub on the line. This can cause slippage or apply excessive loads to the windlass. The line should be made fast to the cleat provided near the windlass to relieve the load on the windlass.

The anchor is hauled in by releasing the line from the cleat and pressing the Windlass Up switch. Always start the engines before hauling the anchor and motor up to the anchor as the line is retrieved to relieve the load on the windlass. Once the anchor is retrieved, independently secure the anchor to the chain binder to prevent it from being accidentally released. This is especially important while the boat is underway.

The windlass manufacturer provides an owner's manual with its product. It is extremely important that you read the manual and become familiar with the proper care and operation of the windlass. Refer to the Operation chapter for tips on anchoring your boat.



Windlass Switches In Helm Switch Panel

WARNING

A WINDLASS MUST BE USED WITH CARE. IT IS EXTREMELY IMPORTANT THAT YOU READ THE OWNER'S MANUAL AND BECOME FAMILIAR WITH THE SAFETY INSTRUCTIONS AND PROPER OPERATION OF THE WINDLASS BEFORE USING IT WITH YOUR BOAT. ALWAYS ENSURE THAT LIMBS, FINGERS, HAIR AND CLOTHING ARE KEPT CLEAR OF THE WINDLASS AND ANCHOR LINE DURING OPERATION.

A PARTIALLY LOWERED AND LOOSE ANCHOR CAN CAUSE CONSIDERABLE DAMAGE TO THE HULL. DO NOT USE A WINDLASS AS A SOLE MEANS OF SECURING AN ANCHOR IN THE BOW ROLLER. ALWAYS SECURE THE ANCHOR TO THE CHAIN BINDER BEFORE OPERATING YOUR BOAT.

11.4 Hull

Engine Mounting System and Swim Platform

Your Crevalle is equipped with an engine mounting system and swim platform that is integrated into the hull and stringer system and designed to equally distribute the stresses of engine weight and thrust throughout the entire hull.

The engine hoses and cables or transom gel coat can be damaged by tilting the engines to the full up position with the engines turned to the wrong position. You should monitor the engines as they tilt to determine the best full tilt engine position for your boat.





Engine Mounting System & Swim Platform

Boarding Ladder

A telescoping boarding ladder is retracted into a compartment in the port side swim platform. To use the ladder, make sure the engines are off and the steering wheel is turned straight ahead or slightly to starboard to move the propellers as far away from the ladder location as possible. Press the latch button to release the ladder and pull it out of the compartment to the down position. Pull the bottom step to extend the ladder. The ladder must be retracted, slid into the compartment and latched before starting the engines.



Ladder Latch Release Button & Ladder Retracted In Compartment

	WARNING	
<p>MOVING PROPELLERS ARE DANGEROUS. THEY CAN CAUSE DEATH, LOSS OF LIMBS, OR OTHER SEVERE INJURY. DO NOT USE THE SWIM PLATFORM OR LADDER WHILE AN ENGINE IS RUNNING. STOP THE ENGINES IF DIVERS OR SWIMMERS ARE ATTEMPTING TO BOARD. ALWAYS PROPERLY STORE THE LADDER BEFORE STARTING THE ENGINES.</p>		

Unassisted Boarding Situations

When using the swim platform ladder in an unassisted boarding situation in deep water, hold the grab rail on the swim platform above the ladder with one hand and brace your feet against the hull for stability. Press the latch button to release the ladder. Then pull it out of the compartment and rotate it to the down position with your free hand. Hold the side rail of the ladder for stability, then use your free hand and feet to extend the ladder.

Use the ladder side rails and platform grab rails for stability while boarding. Remember to retract the ladder and latch it in the compartment before starting the engines.



Ladder Deployed

Exterior Equipment

Underwater Lights

Your boat is equipped with underwater lights mounted in the transom. They are activated by a switch in the helm and should only be used when the boat is in the water and the lights are submerged.

Trim Tabs

The trim tabs are located on the transom below the swim platform. The trim tabs are an important part of the control systems. Refer to the Helm Control Systems chapter for detailed information on the operation of the trim tabs.



Starboard Underwater Light

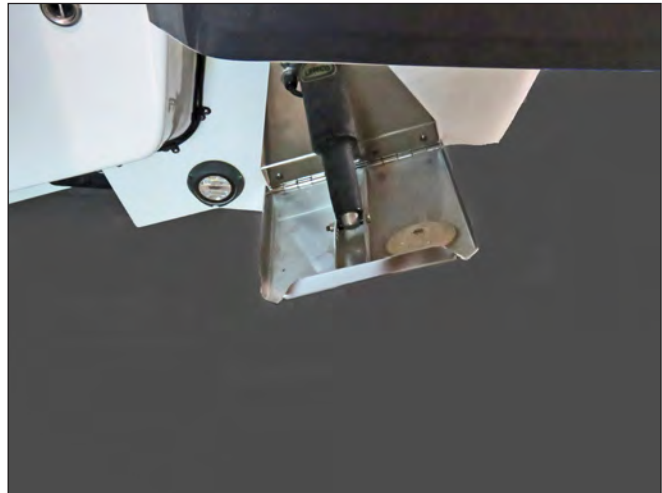

Starboard Underwater Light & Trim Tab

11.5 Cockpit Features

General

Some hatches and doors in the cockpit are secured with automatic “push to close” latches. The latches are released by lifting the handle. Push the door or hatch firmly in the closed position to secure the latch. Gas charged springs or friction hinges are used to hold hatches and doors in the open position.

Some large hatches in the cockpit sole and deck are secured with flush mounted, twist lock latches with handles that store flush in the latch in the open or latched position. There is a large red dot in some handles that indicate that the latch is in the open position and the hatch is not secure. Always make sure that all hatches are closed with the latches in the secured position before operating the boat above idle speed.

A removable access plate in the cockpit sole below the slide out cooler provides access to fuel supply lines and the fuel gauge sender on the fuel tank.

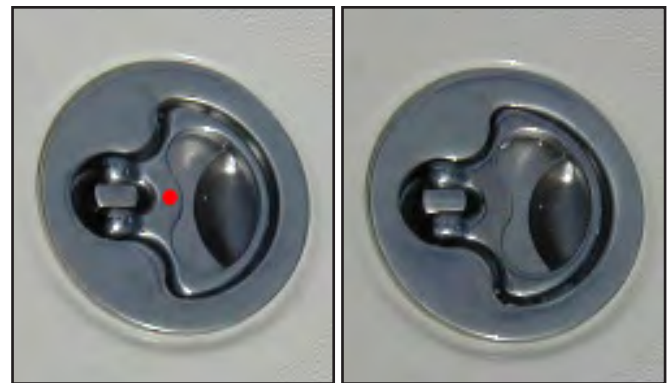



Twist Latch Unlatched
Red Dot Showing

Twist Latch Latched
Red Dot is Not Showing



Transom Door Closed

	WARNING	
<p>IN CERTAIN CONDITIONS, OPEN EXTERIOR DOORS AND HATCHES THAT ARE NOT SECURED PROPERLY CAN SLAM CLOSED UNEXPECTEDLY AND CAUSE INJURY TO PASSENGERS OR DAMAGE TO THE BOAT. SOME DOORS AND HATCHES ARE EQUIPPED WITH FRICTION HINGES, HATCH LIFTERS OR SNAPS AND/OR STRAPS TO SECURE THEM IN THE OPEN POSITION. ALWAYS MAKE SURE THAT THESE HATCHES AND DOORS ARE PROPERLY SECURED WHENEVER THEY ARE IN THE OPEN POSITION.</p>		



Transom Door



A transom door is incorporated into the port side of the transom. It is secured in the closed positions by a flush mounted “push to close” latch on the door. Friction hinges hold the door open. When closing the door, make sure you push the door against the door jam with enough pressure to allow the latch to secure the door.

The transom door should only be opened when the boat is not underway. The door must be latched in the closed position whenever the boat is underway. Never leave the transom door unlatched.

Notice:

Periodically inspect the transom door latch and fittings for wear, damage or loose fit. Any problems should be inspected and corrected immediately.

	WARNING	
<p>THE TRANSOM DOOR SHOULD BE CLOSED AND PROPERLY LATCHED WHENEVER THE ENGINES ARE RUNNING. NEVER OPEN THE TRANSOM DOOR WHILE UNDERWAY OR IN ROUGH SEA CONDITIONS. IN CERTAIN SITUATIONS, AN OPEN TRANSOM DOOR COULD ALLOW A SUBSTANTIAL AMOUNT OF WATER TO ENTER THE COCKPIT CREATING A POTENTIALLY DANGEROUS CONDITION.</p>		

	WARNING	
<p>OPERATING THE BOAT UNDER POWER WITH THE TRANSOM DOOR OPEN MAY ALLOW PERSONS TO FALL OVERBOARD AND INTO BOAT PROPELLERS OR TO BE LOST IN OPEN WATER. ALWAYS CHECK TO MAKE SURE THE TRANSOM DOOR IS PROPERLY CLOSED AND LATCHED BEFORE STARTING THE ENGINES AND NEVER OPERATE THE BOAT UNDER POWER WITH THE TRANSOM DOOR OPEN.</p>		

Exterior Equipment

Dive/Boarding Door

A boarding door is located in the starboard hull side. The door provides divers and swimmers easy, unobstructed access to the water and cockpit. It also makes boarding and exiting the boat much easier in many docking situations.

Friction hinges secure the door in the open position and a special latch mounted on the inboard side of the door secures it when it is closed. The door latch has a spring loaded safety pin. When the door is closed, make sure the latch is completely closed and that the safety pin is snapped into place to prevent the latch from opening accidentally.

The door should only be opened when the boat is not in motion with the engines shutdown. When not being used, the door must be closed and latched. Never leave the side door open or unlatched.



Notice:
Periodically inspect door hinges and hardware for wear, damage or loose fit. Any problems found should be corrected immediately.



Dive/Boarding Door Closed





Dive Door Open & Ladder Deployed

 WARNING 
<p>THE BOARDING DOOR SHOULD BE CLOSED AND PROPERLY LATCHED WHENEVER THE ENGINES ARE RUNNING. NEVER OPEN THE DOOR WHILE UNDERWAY OR IN ROUGH SEA CONDITIONS. IN CERTAIN SITUATIONS, AN OPEN BOARDING DOOR COULD ALLOW A SUBSTANTIAL AMOUNT OF WATER TO ENTER THE COCKPIT CREATING A POTENTIALLY DANGEROUS CONDITION.</p> <p>OPERATING THE BOAT UNDER POWER WITH THE BOARDING DOOR OPEN MAY ALLOW PERSONS TO FALL OVERBOARD AND INTO BOAT PROPELLERS OR TO BE LOST IN OPEN WATER. ALWAYS CHECK TO MAKE SURE THE DOOR IS PROPERLY CLOSED AND LATCHED BEFORE STARTING THE ENGINES. NEVER OPERATE THE BOAT UNDER POWER WITH THE DOOR OPEN.</p>

Dive Boarding Ladder

The boarding ladder is mounted to brackets in the ladder/fire extinguisher storage compartment when it is stored. To use the ladder, make sure the engines are off. Then remove the ladder from the storage clips. Open the dive door and slide the studs into the special receivers in the door jam. Rotate the ladder to the down position. Release the strap securing the steps and pull the bottom step to extend the ladder. To prevent damage to the ladder or hull side, the ladder must be retracted and removed from the door jam and properly se-

cured in the cockpit storage compartment before starting the engines.

 WARNING 
<p>MOVING PROPELLERS ARE DANGEROUS. THEY CAN CAUSE DEATH, LOSS OF LIMBS, OR OTHER SEVERE INJURY. DO NOT USE THE DIVE DOOR LADDER WHILE AN ENGINE IS RUNNING. STOP THE ENGINES IF DIVERS OR SWIMMERS ARE ATTEMPTING TO BOARD. ALWAYS PROPERLY STORE THE LADDER BEFORE STARTING THE ENGINES.</p>

Rod Rack

There is a recessed rod storage rack located below the gunnel on the port side of the cockpit. It is equipped with stretch cords to secure the rods to the racks. Always make sure the rods are properly secured in the storage racks with the rod tips forward.

Stern Bench Seat

Your boat is equipped with a forward facing bench seat in the rear of the cockpit. The seat is designed to fold flush against the cockpit when it is not in use.

To use the seat, pull the top of the seat base out of the recess toward the cockpit. The side supports move out with the seat as it rotates out. When the seat is half way out, lift the rear of the seat with one hand while pushing the front of the seat down with the other hand until it stops in the seat position.

To store the seat, lift the front of the seat with one hand while pushing the rear of the seat down with the other hand until the seat rotates to the half closed position. Push the top of the seat firmly into the recess. The seat will automatically be secured in the stored position when it is completely folded into the recess.

Aft Systems Compartment Access Hatch

A hatch in the rear of the cockpit provides access to the fuel filters, sea chest, pumps, strainers and other equipment in the stern bilge. The aft bilge pumps, livewell pumps, fishbox pumps and optional overboard discharge pump are among the equipment in this compartment. The hatch is held open by a gas charged hatch lifter and secured closed with a flush, compression latch. Always make sure the hatch is closed with the latch in the secured position before operating the boat above idle speed.



Stern Bench Seat Folded In Cockpit Recess



Stern Bench Seat In Seat Position



Aft Systems Compartment Hatch

Exterior Equipment

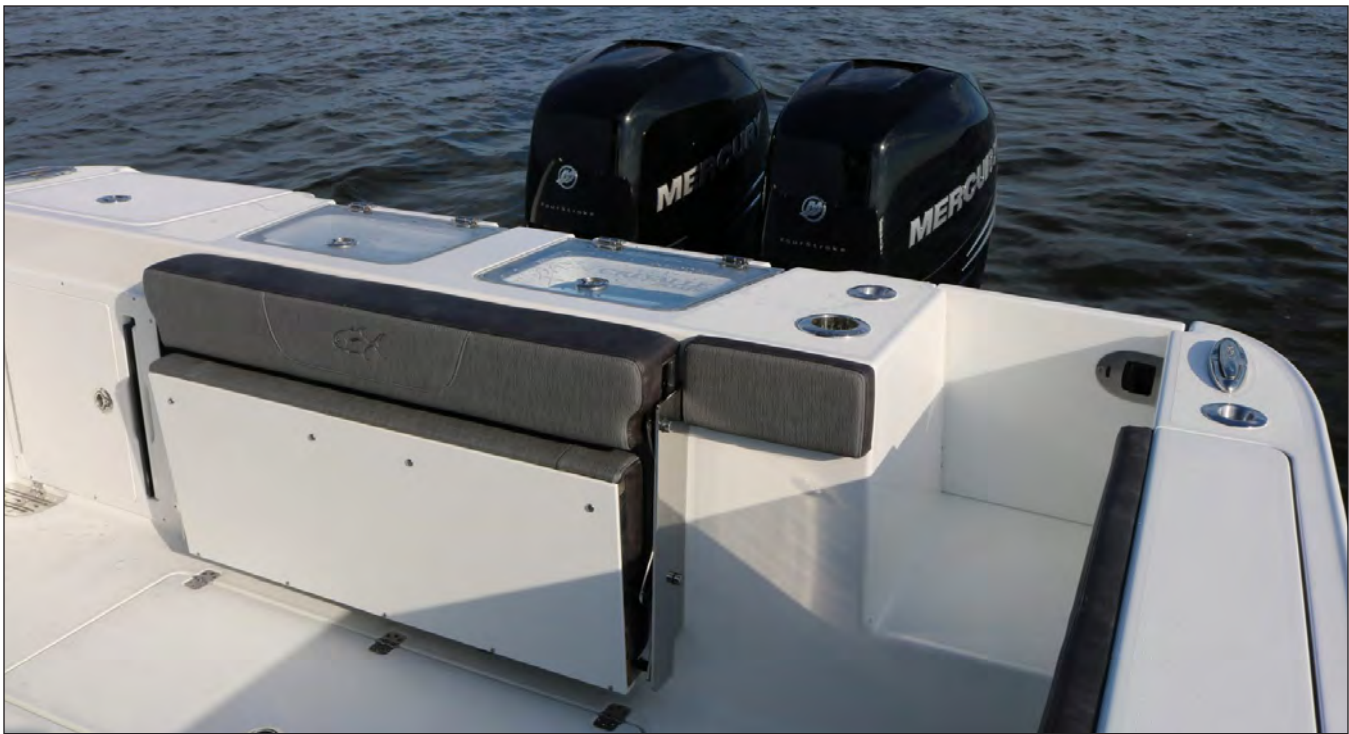

Aft Work Station, Livewells, Bench Seat & Transom Door

Aft Livewells

Two pressurized livewells are located behind the forward facing bench seat in the rear of the cockpit. The livewells are equipped with a Plexiglas hatches with twist lock latches. They are equipped with a light, overflow and flow valves. They drain by gravity to a thru-hull fitting in the hull.

Centrifugal pumps located on the sea chest in the aft systems compartment bilge supply seawater to the baitwells. Adjustable inlet and overflow valves control water level, pressure and flow.

The baitwells should be drained and rinsed clean with fresh water after each use. Refer to the Raw Water System and Drainage Systems chapters for more information on the operation of the baitwells.



Aft Work Station Drawers & Cutting Boards

Aft Work Station

The aft work station is equipped with a freshwater sink, tackle drawers and removable tackle trays. There are two removable cutting boards next to tackle drawers. One can be used for cutting bait and the other can be reserved for food and drink preparation.

The drawers are accessed by opening a hinged door that is secured by a twist lock latch. Always make sure the door is closed and latched before operating the boat.



Aft Work Station Sink

The sink is located below a hatch on the top of the station. The sink faucet is plumbed to the fresh water system and is drained by gravity to a thru-hull fitting in the hull side above the waterline. The hatch is secured with a twist lock latch.

To use the sink, make sure the fresh water system is activated and rotate the faucet to the operating position. The faucet works like faucets in your home when the fresh water system is activated. Always lower the faucet to the stored position and close the hatch when the sink is not being used.

Aft Below Deck Fishboxes

Two large below deck fishboxes are located on each side of the cockpit. Each fishbox hatch is equipped with a gas charged hatch lifter that holds the hatch in the open position. Flush, twist lock latches secure the hatches in the closed position. Always make sure the hatches are closed with the latches in the secured position before operating the boat above idle speed.

Each fishbox is drained by a diaphragm pump out system located in the aft systems compartment bilge.

The pumps are activated by a switch in the helm station. Be sure to monitor the water level in the fishbox and turn the pump off as soon as pumping is complete. A pump could be damaged if it is allowed to run dry for extended periods. The fishboxes should be drained and cleaned after each use.

Refer to the Drainage Systems chapter for more information on fishbox drainage.



Below Deck Fishbox



Below Deck Fishbox Pumps

Exterior Equipment



Bow Seats

Bow Seats and Storage Compartments

The bow seats are equipped with backrest cushions so the seats can be used as a forward facing lounge. Additional storage, Corian counter tops and cup holders are located behind each backrest.

There are two storage compartments located in the bow below the port and starboard seats. Each compartment is designed to accommodate lunch coolers and dunnage. The bow seat cushions are secured to the hatches with snaps and should be removed and stored when the boat is not being used.

Flush, twist lock latches secure the doors in the closed position. Always make sure that the storage compartment doors are closed with the latches in the secured position before operating the boat above idle speed.

Bow Casting Platform/Sun Deck (Optional)

An insert with a nonskid surface is an available option that converts the bow seat area to a casting platform. To convert the bow seats to a casting platform, remove the bow seat cushions and store them in a safe place. Place the casting platform insert on the supports on each bow seat bases to complete the conversion. Install the bow seat cushions and center insert cushion to convert the casting platform to a sun deck.



Bow Seat Storage Compartment



Bow Seats Converted To a Sun Deck

The insert and center cushion should be removed and properly stowed in the lounge seat storage

compartment whenever casting deck or sun lounge is not being used.

Forward Below Deck Storage Compartment

A large storage compartment is located below the center of the cockpit sole, just forward of the console lounge seats. Drain rails around the hatch are connected to the overboard drain system. The compartment drains by gravity to the bilge.

The compartment is equipped with a bracket to secure a casting net bucket. It also provides the mounting location for the optional trolling motor batteries and battery trays. The fresh water pump and strainer are also located in this compartment.

A flush, twist lock latch secures the hatch in the closed position and friction hinges hold it open. Always make sure the hatch is closed with the latch in the secured position before operating the boat above idle speed.

Cockpit Table (Optional)

A removable cockpit table mounts to a pedestal in the cockpit sole, between the bow seats. The table and pedestal are stored in special mounting brackets built into the head compartment.

To use the table, remove the table and pedestal from the head compartment. Insert the pedestal firmly in the base, then install the table on the pedestal. Reverse the process to remove the table.

The table should only be used while running at slow speeds, at the dock or at anchor. Always remove and properly stow the table and pedestal before operating the boat above slow speed. To prevent damage to the table or head compartment, make sure to secure the table when it is stored in the mounting brackets. Also make sure the pedestal is securely fastened to the brackets.

Console Lounge

A double lounge seat with underside storage and forward livewell is located on the console, forward of the windshield. The lounge seat cushion will accommodate two people and has arm rests built into each side that fold flush to the backrest.

Raising the rear seat cushion provides access to a large compartment below the lounge that is equipped with storage for dunnage, washdown hoses and the optional casting platform insert and cushion. This compartment drains overboard and can be used as a cooler.



Forward Storage Compartment Below Bow Seat



Forward Below Deck Storage Compartment



Console Lounge Seat

Raising the forward seat cushion provides access to the forward livewell. The livewell hatch provides access to the well. Refer to the Raw Water Systems chapter for information on the operation of the livewell.

Exterior Equipment

The seat cushion hatches are equipped with special cam actuated hinges that hold each cushion in the open or closed position. Always make sure they are completely closed before operating the boat above idle speed.

Rod Lockers

There are lockable rod storage lockers located on either side of the cockpit near the bow. The locker doors are secured with special locking, flush mounted, twist latches. The rod racks are equipped with tubes to protect rod tips. Always make sure the rods are properly mounted in the locker with the rod tips facing forward and that the doors are closed with the latches in the secured position before operating the boat.



Forward Livewell Below Lounge Seat

Side Storage/Life Jacket Compartments

There are life jacket storage compartments on each side of the cockpit. The tip out compartments are designed to accommodate suspender style life jackets or dunnage.

Each compartment drains to the bilge and is accessed by a door secured with a twist lock latch.



Rod Locker

Ladder & Fire Extinguisher Compartment

The dive ladder, fire Extinguisher, raw water wash-down hose and hardtop shower control valve are located in a storage compartment on the starboard side of the cockpit.

This compartment drains to the bilge and is accessed by a door secured with a twist lock latch.



Ladder & Fire Extinguisher Compartment



Helm Seats with Bolsters Up

11.6 Helm Seats & Tackle Prep Station Helm Seats

The helm seats are equipped with a flip up bolster to provide more room between the seats and the helm. The bolster converts the seat to a leaning post style seat with a backrest, allowing the operator and passenger to sit or stand at the helm. To convert each seat to a leaning post, lift the front of the seat cushion to raise the bolster and push it back above the seat cushion. A molded in footrest on the rear of the console makes the helm more comfortable when the bolsters are set to the seat position.

The seat bases are equipped with slide tracks that allow the seats to move fore and aft. Press the slide lock lever located at the starboard front side of the seat base to release the slide track and adjust the seat to the desired position. Release the lever to lock the seat in position.

Arm rests on each side provide a more comfortable driving position and swing up into the backrest cushion to make it easier to enter and exit the helm area. There are also folding center arm rests with cup holders between the seats.



Helm Seat Slide Track Lock Release Lever

The battery compartment, battery switch panel and two storage compartments are located behind hinged doors on the forward side of the helm seat base. The doors are secured with one or two twist lock latches, depending on the door size. Always make sure the doors are closed and latched before operating the boat.

Exterior Equipment

Center Tackle Prep Station

A tackle prep station equipped with tackle storage, drawers and a slide out cooler is located in the helm seat base, aft of the helm seats. There is a compartment with removable tackle storage trays in the center of the prep station. Two drawers on each side of the tackle trays provide storage for hooks, leaders, knives and tools. One drawer is equipped with a leader reel holder and ceramic knife cutter.

The tackle trays and drawers are accessed by opening a door that becomes a work station when open. When closed, a bolster on the outside of the door provides a backrest for the cooler bench seat. The door is hinged at the bottom and secured by two twist lock latches. Always make sure the door is closed and latched before operating the boat.

Slide Out Cooler/Bench Seat

A slide out cooler is located in a compartment in the rear of the helm seat/tackle station base, below the tackle station. The sliding base assembly is equipped with a spring loaded slide bolt latch that secures the cooler and base in the compartment. There is a removable cushion on the cooler lid that converts the cooler to a rear facing bench seat when it is slid out.

To slide the cooler out of the compartment, release the latch and slide the cooler out. To store the cooler, push the cooler into the compartment and secure the base with the latch.

The cooler can be removed by pulling it out of the compartment and lifting it out of the base. Make sure the cooler is slid completely into the compartment and latched before operating the boat at high speed.

Notice:

Access to the fuel tank sending unit is located below a removable hatch that is accessible when the cooler slide assembly is pulled out and the cooler is removed.



Center Bait Prep Station



Bait Prep Station & Slide Out Cooler



Slide Out Cooler & Bench Seat

11.7 Center Console

Helm

The steering, engine controls, engine instruments and switches for exterior equipment, navigation lights and other 12 volt DC accessories are located on the helm station. A molded-in electronics mounting panel is located forward of the engine controls. A 12 volt USB connection is also located in the helm.

Service panels in the rear head compartment bulkhead can be opened or removed to service helm equipment and install electronics or other accessories. There are also fuse panels that provide protection for electronics, helm accessories, digital switching or other equipment added by you or your dealer.

Windshield

Your boat is equipped with a tinted glass windshield and could be equipped with an optional windshield wiper and washer. The front and side panels are tempered safety glass.

Ventilation through the windshield is provided by an opening center panel at the top of the windshield. The vent panel is opened and closed by an electric actuator controlled by the Vent Extend/Retract switches in the helm switch panel.

A windshield wiper and washer is an available option. The windshield wiper should only be used when the windshield is wet. The windshield glass can be scratched by activating the wiper when there is dried salt or dirt on the windshield.

The windshield/hardtop frame is powder coated aluminum. Powder coated aluminum is very durable and provides excellent resistance to the corrosive effects of saltwater, however, it must be maintained properly and certain precautions must be observed.

The windshield should be washed after each use with soap and water to keep it clean and reduce the corrosive effects of the saltwater. Saltwater allowed to remain on the windshield frame will eventually begin to attack the aluminum, usually around fasteners and hardware mounted to the frame.

Refer to the Routine Maintenance chapter for more information on the care and maintenance of powder coated aluminum.



Helm



Console Windshield & Vent

Exterior Equipment

Head Compartment Door

The head compartment door is on the port side of the console. A friction hinge automatically holds the door in the open position and a lockable, push to close latch with a dead bolt secures the door when it is closed.

It is very important that the door is secured properly in the closed position whenever the boat is operated above idle speed. The cabin door is heavy and if the door is not closed and properly latched, it could slam shut when the boat rocks and pinch someone's fingers between the door and cabin or damage the door.



Head Compartment Door



WARNING



NEVER LEAVE THE DOOR OPEN WHEN THE HEAD COMPARTMENT IS NOT BEING USED. IF THE DOOR IS LEFT OPEN AND UNLATCHED, IT COULD SLAM UNEXPECTEDLY AS THE BOAT ROCKS, DAMAGING THE DOOR OR CAUSING AN INJURY TO A PASSENGER. ALWAYS MAKE SURE THE DOOR IS PROPERLY SECURED IN THE CLOSED POSITION WHEN THE HEAD COMPARTMENT IS NOT BEING USED.



Hard Top

11.8 Hardtop

The standard hardtop consists of a laminated fiberglass top mounted to a welded powder coated aluminum frame that is bolted to the console, helm seat base/prep station and cockpit sole. It is equipped with a storage compartment above the helm and LED overhead lighting. There is also storage for life jackets in a compartment above the helm.

The top is designed to accommodate radio antennas, radar antennas, forward and aft spreader lights and navigation lights. It is also equipped with outriggers and rod holders. The spreader lights, optional windshield wiper, hardtop lights and opening vent panel are controlled by switches in the helm switch panel.

The hardtop is not designed to support the additional weight of heavy items like a life raft. Radar and electronics antennas must be mounted to the top between the front and rear legs in the mounting areas provided. Do not mount any antennas or equipment to the brow area forward of the front legs. The hardtop frame is not designed to support the weight of accessories in this area and could be damaged.

Retractable Aft Sunshade (Optional)

The optional retractable awning extends to provide shade for the rear cockpit. Electric actuators on each side of the hardtop extend or retract the aw-



Retractable Aft Sunshade

ing. The actuators are controlled by the Awning Extend/Retract switches in the helm switch panel.

To extend the sunshade, remove rods from the rocket launcher rod holders at the rear of the hardtop. Press and hold the extend switch to extend the awning. Press and hold the retract switch to retract it. The switches automatically return to the OFF position when released. Limit switches built into the actuators automatically stop the awning when it is fully extended or retracted.

Exterior Equipment

Bow Sunshade (Optional)

The optional bow sunshade provides shade for the bow seating. The bow shade consists of support pole receivers located on the gunnels, support poles and a canvas shade which are stored in a canvas bag.

- To install the sunshade, remove the sunshade and poles from storage bag.
- Insert poles into the sunshade pole receivers.
- Unfold sunshade and loosen the cinch straps all the way and attach to the receivers on the front of the hardtop.
- Pull canvas and attach it to the poles.
- Pull cinch straps tight to tighten the canvas.

11.9 Aftermarket Hardtop or Tower

Crevalle does not recommend installing an aftermarket hardtop or tower. An improperly designed or installed fabrication can cause structural damage to the deck and void the Crevalle Limited Warranty. Additionally, Crevalle will not be responsible for any damage resulting from the installation of a fabrication not installed at the Crevalle factory.

Chapter 12: INTERIOR EQUIPMENT

12.1 Head Compartment

The head compartment is equipped with a light, fresh water sink with a shower and a porcelain toilet with a holding tank. Storage compartments are located in the forward bulkhead and below the sink.

Natural lighting and fresh air is provided by an opening port window on the side of the compartment and in the compartment door. Additional lighting is provided by a 12 volt light in the headliner controlled by a switch on the light fixture.

Rod Storage

Vertical rod storage is located at the front and rear bulkheads. Rod butts mount into removable bases on the head compartment sole with reels facing away from the bulkheads. Rod are secured by holders and a stretch cord on the access hatches in each bulkhead forward of the rod butt holders in the sole. Always make sure the rods are properly secured with the rod tips up.

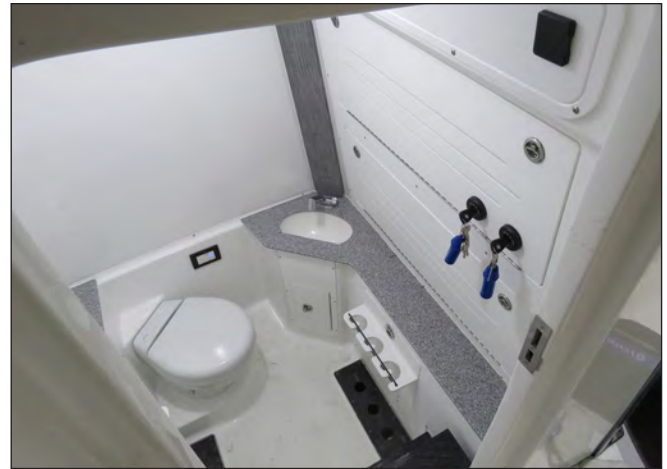

Head Compartment



Overhead Light & Switch



Aft Rod Storage



Forward Rod Storage

Interior Equipment



Removable Upper Access Panel



Hinged Access Doors

Equipment Access panels

Access to the back of the helm is provided by opening hinged doors and a removable upper panel in the rear bulkhead. The hinged doors are secured with twist lock latches.

The ignition switches for some engine installations are mounted on the upper hinged door. This panel must be opened carefully and the ignition switch wires disconnected as the door is opened if the switches are mounted on the door.

Other removable access panels in the head compartment liner provide access to the windshield wiper motor and other components.



Lower Hinged Access Door Open

Center Bilge Access door

A removable door on the bottom of rear bulkhead provides access to the center bilge and forward bilge pump, automatic switch and other equipment mounted in the center bilge. The door is secured with a twist lock latch.

The rear rod holder is mounted to this door, so rods must be removed before this door can be opened and removed to provide access to the bilge.



Center Bilge Access & Forward Bilge Pump

Forward Storage compartment & Bilge Access Door

A removable door on the bottom of forward bulkhead provides access to the forward bilge and overboard waste discharge pump, overboard waste discharge valve and a storage compartment. The door is secured with a twist lock latch.

The forward rod holder is mounted to this door, so rods must be removed before this door can be opened and removed to provide access to the compartment.

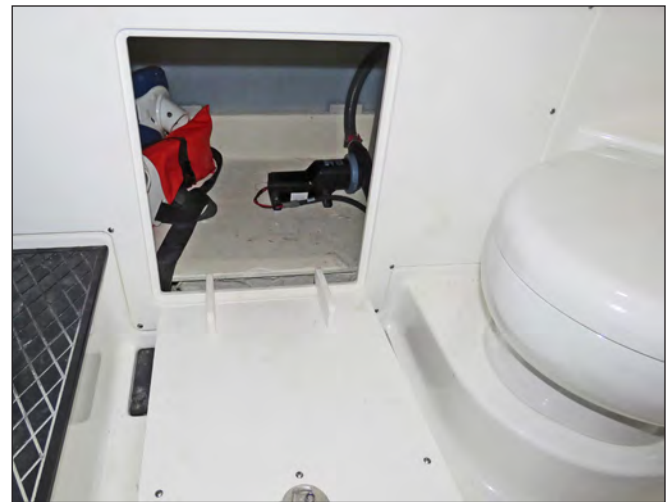

Forward Storage Compartment & Forward Bilge Access

12.2 Porcelain Marine Toilet

The porcelain 12 volt marine toilet is connected to the pressurized fresh water system which results in less odor in the head compartment. It has an automatic pumping device that fills and empties the bowl. Once a button on the control is pressed, the entire cycle is completely automatic. The system uses very little water, approximately 2.27 quarts (2.5 liters) per flush.

To use the toilet, make sure the fresh water system is activated. Then press the "Add Water" button on toilet control panel to add a preset amount of water to wet the bowl. After using the toilet, pressing the "Flush" button starts an automatic flushing cycle that moves the waste to the holding tank and leaves the bowl clean and dry in the rest position.

The head contains an integrated, high-speed turbine grinding pump that transfers waste to the holding tank where it remains until it is pumped out by a waste dumping station or the optional overboard discharge system.

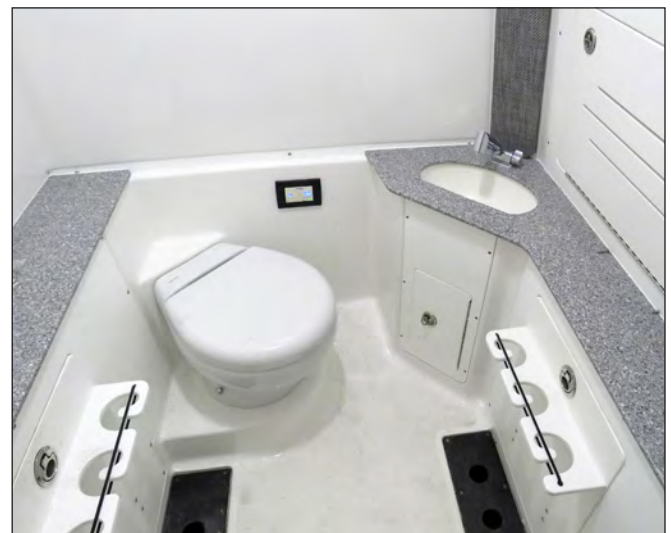

Tecma Marine Toilet

The fluid level in the waste/holding tank is monitored by a lighted LED symbol in the in the lower starboard corner of the toilet control panel. The symbol lighted green indicates the holding tank is less than half full. The symbol lighted yellow indicates the tank is at least half full. The symbol lighted red indicates the tank is full and flushing is not recommended. A lockout system built into the control panel prevents the toilet from flushing when the holding tank is full.

Refer to the toilet manufacturer owner's manual for more information on the operation of the marine head system.



Tecma Toilet Control Panel

Interior Equipment

12.3 Head System Holding Tank

The holding tank is located in the forward bilge. When the tank is full, the red LED light on the toilet control panel will be lit, indicating that flushing is not recommended. The tank must either be pumped out by an approved waste dumping station through the waste deck fitting or the overboard discharge pump.

A lockout system built into the toilet prevents it from flushing when the holding tank is full. You should not attempt to bypass the lockout and flush the toilet when the tank is full. An overfilled holding tank will force waste into the holding tank vent filter. This will clog the vent filter and could cause damage to the holding tank. It will also cause unpleasant odors in the head compartment and cockpit.

To pump out the holding tank with the overboard waste discharge system, open the valve at the discharge thru-hull fitting in the forward head compartment bilge. Activate overboard macerator using the controls in the digital switching system. Monitor the fluid level closely as the tank is pumped. Turn off the overboard pump when pumping is complete. Then close the ball valve at the thru-hull fitting.

Notice:

Monitor the pumping operation as the overboard discharge pump drains the holding tank. Be prepared to turn the pump off immediately when draining is complete.

Notice:

In order to comply with current State, Federal and Coast Guard regulations, the valve at the discharge thru-hull fitting must be turned off and secured whenever the boat is operating in areas where the discharge of sewage is prohibited.



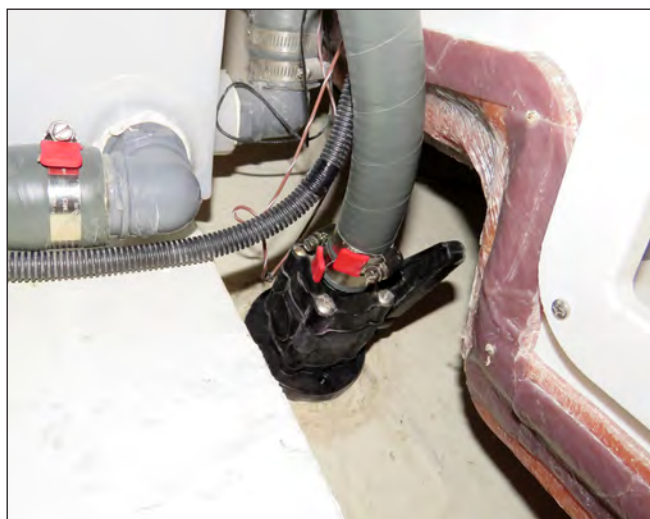

Holding Tank Waste Deck Pump Out Fitting



Waste Overboard Discharge Thru-Hull Valve



Waste Overboard Discharge Pump & Holding Tank

	CAUTION	
<p>IN MANY AREAS IT IS ILLEGAL TO PUMP HEAD WASTE DIRECTLY OVERBOARD. VIOLATION OF THESE POLLUTION LAWS CAN RESULT IN FINES OR IMPRISONMENT. ALWAYS KNOW THE LAW FOR THE AREAS IN WHICH YOU BOAT. NEVER DUMP HEAD OR HOLDING TANK WASTE OVERBOARD ILLEGALLY.</p>		

Head System Maintenance

The head should be cleaned and inspected for leaks regularly.

The holding tank should be pumped out and flushed as needed. Periodically add chemical to the holding tank to help control odor and to chemically break down the waste. See the head manufacturer owner's manual for additional operating and maintenance information.

The vent hose for the holding tank is equipped with a charcoal filter to reduce odor from the holding

tank. The filter should be changed once a year or if the holding tank has become overfilled, which will plug the filter and could cause damage to the waste system.

Notice:

The head system must be properly winterized before winter lay-up. Refer to the Seasonal Maintenance chapter and the manufacturer owner's manual for winterizing instructions.

NOTES

ROUTINE MAINTENANCE

13.1 Exterior Hull & Deck Hull Cleaning Below The Water Line

When the boat is removed from the water, clean the outer bottom surface immediately. Algae, grass, dirt and other marine growth is easier to remove while the hull is still wet. Use a pressure cleaner or a hard bristle brush to clean the surface.

Bottom Painting

If the boat is to be left in saltwater for extended periods, the hull must be protected from marine growth by antifouling paint. Because of variations in water temperature, marine growth and pollution in different regions, a qualified boat yard in your area should be consulted when deciding what bottom paint system to apply to your hull. This is extremely important as pollution and marine growth can damage fiberglass hulls.

Use only standard antifouling paints and fiberglass wax removers and primers recommended by the antifouling paint manufacturer when preparing the hull for bottom paint. Light sanding, just enough to scuff the gel coat or a skip sand primer system can be used to prepare the hull for bottom paint. The use of a coating other than standard antifouling paint or epoxy barrier coatings are not recommended and will void the hull blister warranty.

Do not allow the hull antifouling paint to contact the outboard motor. Most antifouling paints designed for hull bottoms contain copper and can cause severe galvanic corrosion damage to the motor. Always leave at least a 1" barrier between the hull bottom paint and outboard motors.

CAUTION

SANDBLASTING THE HULL BOTTOM WILL DAMAGE THE FIBERGLASS. USE A FIBERGLASS WAX REMOVER AND SAND TO SCUFF THE GELCOAT SURFACE. THE INSTRUCTIONS AND RECOMMENDATIONS OF THE BARRIER COATING AND ANTIFOULING PAINT MANUFACTURERS SHOULD BE FOLLOWED EXACTLY.

CAUTION

BARRIER COATINGS AND BOTTOM PAINT SHOULD BE APPLIED ONLY BY QUALIFIED MARINE PROFESSIONALS IN A BOAT YARD OR DEALERSHIP THAT SPECIALIZES IN THEIR APPLICATION. USE ONLY STANDARD, HIGH QUALITY ANTIFOULING PAINTS AND BARRIER COATINGS FROM NAME BRAND MANUFACTURERS SUCH AS INTERLUX AND PETTIT.

DO NOT ALLOW THE HULL ANTIFOULING PAINT TO CONTACT THE OUTBOARD MOTOR. MOST ANTIFOULING PAINTS DESIGNED FOR HULL BOTTOMS CONTAIN COPPER AND CAN CAUSE SEVERE GALVANIC CORROSION DAMAGE TO THE OUTBOARD DRIVE UNIT. USE ONLY ANTIFOULING PAINT DESIGNED FOR OUTBOARD MOTORS IF APPLYING ANTIFOULING PAINT TO THE ENGINE. ALWAYS LEAVE A ONE INCH BARRIER BETWEEN THE HULL BOTTOM PAINT AND OUTBOARD MOTOR.

Most bottom paints require some maintenance. Proper maintenance is especially important when the boat is in saltwater and not used for extended periods or after dry storage. If the hull bottom has been painted with antifouling paint, contact your dealer or local boat yard for the recommended maintenance procedures.

Sacrificial Anodes

Sacrificial anodes are installed on the outboard engines. Additional anodes are installed on the trim tab planes.

The anodes are less noble than copper based alloys, aluminum, cast iron and stainless steel. They will deteriorate first, protecting the more noble engine and underwater hardware against galvanic corrosion. Anodes should be checked monthly and changed when they are 75% of their original size. Additionally, anodes that are subjected to frequent wetting and drying require periodic scuffing with sandpaper to remove scale and oxidation to maintain their effectiveness.

When replacing anodes, make sure the contact surfaces are clean, shiny metal and free of paint and corrosion. Never paint over the anode. The bonding system should be inspected by a qualified marine electrician once a year to make sure all connections are sound and there is continuity throughout the system.

Routine Maintenance

Boats stored in saltwater will normally need to have the anodes replaced every 6 months to one year. Anodes requiring replacement more frequently may indicate a stray current problem within the boat or at the slip or marina. Anodes that do not need to be replaced after one year may not be providing the proper protection. Loose or low quality anodes could be the problem. There could also be a problem in the bonding system. Contact your dealer for the proper size and type of anodes to be used and the specific installation procedure.

Notice:

Using the recommended sacrificial anode is more critical when stainless steel propellers are installed. Consult your dealer or the engine manufacturer for information on the proper anode for your boating area.

Fiberglass Gelcoat Surfaces

- Keep the gelcoat surface out of direct sunlight or covered when it is not in use.
- Wash gelcoat frequently (daily in salt or polluted environments) with mild detergent and plenty of fresh water. Remove any stains quickly. Gelcoat is microscopically porous, so long term staining may become permanent.
- Regularly (monthly in salt or polluted environments) wax gelcoat surfaces with marine grade wax recommended for fiberglass finishes. The washing and waxing of your boat will have the same beneficial effects as they have on an automobile finish. The wax will fill minute scratches and pores thus helping to prevent soiling and will extend the life of the gelcoat.

DON'TS

- Do not use plastic or other nonporous (non-breathable) materials to cover gelcoat surfaces. Trapped moisture from condensation can cause gelcoat damage. Shrink wrap storage covers must be properly ventilated, including hull sides.
- Do not use abrasives, bleaches, ammonia, acids or harsh detergents. See your dealer for special marine formulations. Harsh abrasive and chemical cleaners are not recommended because they can damage or dull the gelcoat, reducing its life and making it more susceptible to stains.

- NEVER apply wax or buffing compound to a gelcoat surface in direct sunlight.

Chalking, stains and minor scratches can be removed in most cases with careful rubbing and polishing with appropriate compounds or chemicals and is best done by a professional - see your dealer.

If the fiberglass should become damaged and need repair, contact your dealer or Crevalle Customer Service for assistance in finding an authorized repair person to make the repairs.

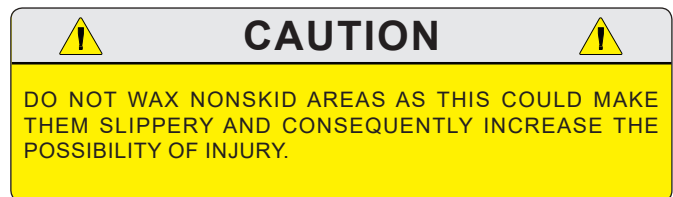

Stainless Steel Hardware

When using the boat in saltwater, the hardware should be washed with soap and water after each use. When your boat is used in a corrosive environment such as saltwater, water with a high sulfur content or polluted water, the stainless steel will periodically develop surface rust stains. This is perfectly normal under these conditions.

The following guidelines will help keep stainless steel looking good for many years:

- Clean stainless steel frequently (daily in salt or polluted environments) with mild soap and plenty of water. Any cleaner safe for use on glass is usually safe for stainless.
- Remove rust spots (especially around welds) immediately with a brass, silver or chrome cleaner. Irreversible pitting will develop under rust allowed to remain on stainless for any period of time.
- Remove rust stains on gelcoat. See dealer for recommended product.
- Stainless Steel can normally be cleaned and protected by using a high quality boat or automotive wax or a commercial metal cleaner and protectant.

Never do the following on stainless steel:

- Do not use coarse abrasives like sandpaper or steel wool which may actually cause rusting.
- Do not use acids or bleaches which may etch the naturally occurring protective coating.
- Do not leave stainless steel in contact with iron, steel or other metals which cause contamination leading to rust or corrosion.

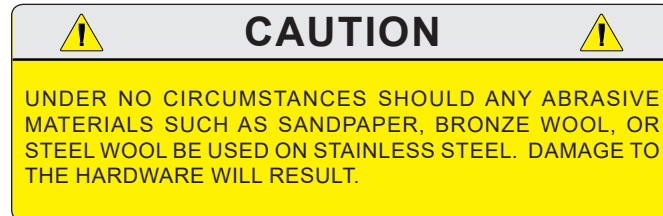

Anodized Aluminum Surfaces

Anodized aluminum should be washed periodically with soap and water to keep it clean. If the boat is used in saltwater or polluted water, the aluminum should be washed with soap and water after each use. Saltwater allowed to remain on anodized aluminum will penetrate the anodized coating and attack the aluminum.

Hardtops, Bimini tops or T-tops with canvas and/or fiberglass tops require special attention to the anodized aluminum just below the top. This area is subject to salt build up from salty condensation and sea spray. It is also frequently overlooked when the boat is washed and will not be rinsed by the rain. Consequently, the aluminum just below the top is more likely to become pitted than the exposed aluminum on the structure. Make sure the aluminum in this area is washed frequently with soap and water and rinsed thoroughly. Pay particular attention to places where the top material or lacing contact the frame. Once a month coat the entire frame with a metal protector made for anodized aluminum to protect against pitting and corrosion caused by the harsh effects of saltwater. Do not use automotive or boat wax designed for paint or gel coat on anodized aluminum. The wax can contaminate the aluminum and damage the anodized surface.

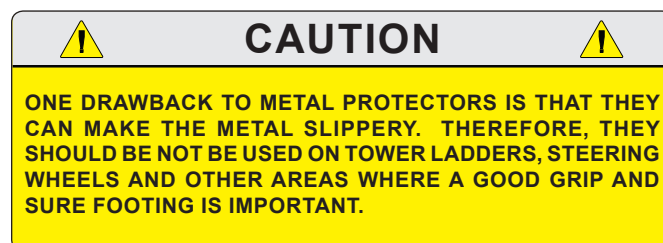

Stains can be removed with a metal polish or fine polishing compound. To minimize corrosion, use only high quality stainless steel fasteners on aluminum fabrications. Isolate the fasteners from the aluminum by using fiber washers and caulking compound or Tef Gel to bed hardware and fasteners mounted to aluminum fabrications. If the anodized coating is badly scratched, it will require special attention and more frequent cleaning to the damaged area. With proper care, anodized aluminum will provide many years of service.

Powder Coated Aluminum

Powder coated aluminum should be washed periodically with soap and water to keep it clean. If the boat is used in saltwater or polluted water, the aluminum should be washed with soap and water after each use. Saltwater allowed to remain on powder coated aluminum will penetrate the coating and attack the aluminum, usually around fasteners and hardware mounted to the aluminum.

Pay special attention to the area just below the top. This area is subject to salt buildup from salty condensation and sea spray. It is also frequently overlooked when the boat is washed and will not be rinsed by the rain. Consequently, the powder coating near fasteners and hardware mounted just below the top is more likely to be attacked by the salt and become corroded than the exposed areas on the structure. Make sure the aluminum in this area is washed frequently with soap and water and rinsed thoroughly. Pay particular attention to places where the top material and/or lacing contact the frame.

Once a month check the entire frame for damaged powder coating and corrosion around fasteners and hardware. Nicked or badly scratched powder coating can be sanded and touched up with enamel paint. Corrosion around fasteners will have to be sanded, then touched up with paint. The fasteners will require fiber washers and sealing with caulk or Tef Gel to isolate the fastener from the aluminum and prevent damage to the paint or powder coating when the fastener is installed. Periodically applying automotive or boat wax to the powder coating will provide additional protection from the harsh effects of saltwater.

Always repair scratches, nicks and corroded areas in powder coating as soon as possible. Corrosion left unaddressed will lift the powder coating allowing moisture to travel between the powder coating and the aluminum causing the corrosion to spread below the coating and damage the aluminum.

Routine Maintenance

If excessive chipping and peeling occurs, it could be an indication of an electrical fault in the boat or aluminum fabrication. You should contact a qualified marine electrician to inspect your boat immediately and correct the problem if you suspect that your boat may have a fault in the aluminum frame. You should also contact your dealer.

Notice:

Boats that are towed behind larger vessels require special attention to the aluminum hardware. The salt spray, salty steam, and chemicals in exhaust gases are particularly corrosive and will damage the surface of anodized or powder coated aluminum. It is imperative that the boat and the aluminum are cleaned thoroughly at the completion of each trip or at the end of each day on long cruises to reduce accelerated deterioration of the anodizing or powder coating and premature corrosion to the aluminum.

Chrome Hardware

Use a good chrome cleaner and polish on all chrome hardware.

Acrylic Plastic Glass

Acrylic glass scratches easily. Never use a dry cloth or glass cleaning solutions on acrylic. Use a soft cloth and mild soap and water for routine cleaning. Solvents and products containing ammonia can permanently damage acrylic plastic glass.

Fine scratches can be removed with a fine automotive clear coat polishing compound. A coat of automotive or boat wax is beneficial to protect the surface.

Do not use the following on acrylic glass:

Abrasive cleaners	Acetone
Solvents	Alcohol
Cleaners containing ammonia	Glass cleaners

12.2 Upholstery, Canvas & Enclosures

Vinyl Upholstery

The vinyl upholstery used on the seats, cushions and bolsters should be cleaned periodically with mild soap and water. Any stain, spill or soiling should be cleaned up promptly to prevent the possibility of permanent staining. When cleaning, always rub gently. Avoid using products containing ammonia, powdered abrasive cleaners, steel wool, ink, strong solvents, acetone and lacquer

solvents or other harsh chemicals as they can cause permanent damage or shorten the life of vinyl. Never use steam heat, heat guns or hair dryers on vinyl.

Stronger cleaners, detergents and solvents may be effective in stain removal, but can cause either immediate damage or slow deterioration. Lotions, sun tan oil, waxes and polishes, etc., contain oils and dyes that can cause stiffening and staining of vinyls.

- Dry soil, dust and dirt - Remove with a soft cloth.
- Dried on dirt - Wash with a soft cloth dampened with water.
- Variations in surface gloss - Wipe with a water dampened soft cloth and allow to air dry.
- Stubborn dirt - Wash with a soft cloth dampened with Ivory Flakes® and water. Rinse with clean water.
- Stubborn spots and stains - Spray with either Fantastik Cleaner® or Tannery Car Care Cleaner® and rub with a soft cloth. Rinse with clean water.
- Liquid spills - Wipe immediately with a clean absorbent cloth. Rinse with clean water.
- Food grease and oily stains - Spray immediately using either Fantastik Cleaner® or Tannery Car Care Cleaner®, wiping with a soft cloth. Take care not to extend the area of contamination beyond its original boundary. Rinse with clean water.

Acrylic Canvas (Sunbrella)

Modern, bright colored canvas tops are usually fabricated from acrylic fabrics with the trade names like Sunbrella®, Argonaut®, etc. Acrylic fabrics look similar to cotton canvas but are much more durable and color fast.

Acrylic canvas can be cleaned by using Ivory Flakes, Ivory Liquid or another mild soap and water. Scrub lightly and rinse thoroughly to remove the soap. Do not use detergents, as they will deteriorate the waterproofing in the fabric. The underside can be brushed with a soft brush and sprayed with a disinfectant to prevent the accumulation of dirt and mildew. The top or accessories should never be folded or stored wet. In fresh water areas, the top and curtains should

be washed weekly. This is particularly important if the boat is stored near a highway, airport or in a large city. Residue from jet fuel, exhaust fumes and industrial pollution can shorten the life of tops and enclosures.

In saltwater areas, the top and curtains should be rinsed with fresh water after each use and at least weekly if it is stored outside. Saltwater attracts moisture and dirt can shorten the life of fabric tops and enclosures. The salt is also abrasive and can cause premature wear in the fabric and stitching.

After several years, the acrylic canvas may lose some of its ability to shed water. If this occurs, wash the fabric and let it dry thoroughly. Then treat the outside surface with a commercially available waterproofing designed for this purpose. Waterproofing is available in bulk at most canvas shops. One-gallon garden sprayers are excellent for applying waterproofing.

Notice:
Some leakage at the seams is normal and unavoidable with acrylic enclosures.

Laminated Vinyl Tops

Laminated vinyl top material is a lamination of two plies of specially formulated vinyl with an inner reinforcing core fabric. The most common trade name for this fabric is Weblon.® It is not unusual for the interior ply to be a different color than the exterior. There is a greater tendency for this type of fabric to leak at the seams than with acrylic or vinyl coated polyester. Paraffin wax that matches the top can be used to seal the seams if necessary.

Laminated vinyl fabrics should be cleaned periodically by using Ivory Flakes, Ivory Liquid or another mild soap and water. Scrub lightly and rinse thoroughly to remove the soap. Do not use detergents or harsh cleaners like bleach and ammonia. They will attack the vinyl in the fabric and shorten its life. The top or accessories should never be folded or stored wet.

In fresh water areas, the top and curtains should be washed weekly. This is particularly important if the boat is stored near a highway, airport or in a large city. Residue from jet fuel, exhaust fumes and industrial pollution can shorten the life of tops and enclosures.

In saltwater areas, the top and curtains should be rinsed with fresh water after each use and at least weekly if it is stored outside. Saltwater attracts

moisture and dirt can shorten the life of fabric tops and enclosures. The salt is also abrasive and can cause premature wear in the stitching.

Clear Curtains And Connectors

Side curtains and clear connectors can be cleaned with mild soap and water. They should not be allowed to become badly soiled. Dirt, oil, mildew and cleaning agents containing ammonia, will shorten the life of the vinyl that is used for clear curtains. After cleaning the curtains and allowing them to dry, apply a non-lemon furniture polish or an acrylic glass and clear plastic protector to extend the life of the curtains.

Vinyl curtains should be stored either rolled or flat, without folds or creases. Folding the curtains will make permanent creases that could cause the vinyl to crack.

Notice:
Do not use any polish containing lemon scents or lemon. The lemon juice will attack the vinyl and shorten its life.

Snaps should be lubricated periodically with Teflon or silicone grease or a lubricant designed for snaps. Zippers should be lubricated with silicone spray, paraffin or silicone stick.

Strataglass

Strataglass® is a special coated vinyl that could be used in the curtains for the hardtop enclosure. The coating protects the vinyl glass and resists scratching. Waxes and Plexiglas polishing compounds should not be used on strataglass as the protective coating prevents them from penetrating into the vinyl and they will build up on the surface. These products will create a hazy, greasy appearance that will affect the clarity of the strataglass. Products that repel water, like Rainex®, should not be used as they will not take well to the surface and could appear spotty and may also yellow or dull the Strataglass over time.

Strataglass can be cleaned by rinsing off dirt or salt deposits with fresh water, then washing with a clean cloth and mild soap. Chamois dry to remove water spots and improve clarity. If a polish is accidentally used, use Windex® or its equivalent to remove it. While window cleaners will destroy the standard vinyl normally used in side curtains and clear connectors, it will not harm strataglass. Always roll down the curtains and snap in place at the end of each day so the curtains will maintain their shape and to minimize fold distortions.

Routine Maintenance

Depending upon usage, it is recommended that an occasional application of Aquatech Strataglass Cleaner be done. Treat this like a polish, as opposed to a cleaner - wash and dry curtains first, then apply Aquatech Strataglass Cleaner, actually buffing the surface to a beautiful sheen. This is not just a wipe on/ wipe off product...it needs to be buffed to perform.

Remember, the coating on strataglass is scratch resistant and not scratch proof. Always handle the curtains with care and never roll up curtains that are salty or dirty. If you have any questions about the clear curtains used on your boat, please contact the Crevalle Customer Service Department.

Hardtop enclosures must be removed when trailering. Canvas enclosures are not designed to withstand the extreme wind pressure encountered while trailering and will be damaged. Always remove and properly store the enclosure before trailering your boat.

12.3 Interior

The cabin or console interior can be cleaned just like you would clean a home interior. To preserve woodwork, use teak oil. To maintain carpeting, use a vacuum cleaner. Because air and sunlight are very good cleansers, periodically put cushions, sleeping bags, etc. on deck, in the sun and fresh air, to dry and air out. If cushions or equipment get wet with saltwater, remove and use clean, fresh water to rinse off the salt crystals. Salt retains moisture and will cause damage. Dry thoroughly and reinstall.

If you leave the boat for a long period of time, put all cushions on their sides, open all interior cabin and locker doors and hang a commercially available mildew protector in the cabin.

Notice:

Always read the label carefully on mildew protectors. Remove the protector and allow the cabin to ventilate completely before using the cabin.

Counter Tops - Corian Surfaces

A mild liquid detergent and water or ammonia-based cleaners will remove most dirt and stains from Corian. For heavy cleaning, oil and grease, use Fantastik spray cleaner. Rinse with a clean cloth moistened with fresh water. Wipe dry with a clean cloth.

In most cases, Corian can be repaired if accidentally damaged. Minor damage, including scratches, general or chemical stains, scorches or burns and minor impact marks, can be repaired with a light abrasive cleanser and a Scotch-Brite® pad. For heavier damage, light sanding and machine buffing may be necessary so contact your dealer or a professional.

- Avoid exposing Corian to strong chemicals, such as paint removers, oven cleaners, etc. If contact occurs, quickly flush the surface with water.
- Remove nail polish with a non acetone-based polish remover and flush with water.
- Do not cut directly on Corian counter tops.

12.4 Bilge, Pumps & Components

- To keep the bilge clean and fresh, it is recommended that you use a commercial bilge cleaner on a regular basis. Follow the directions carefully.
- All exposed pumps and metal components in the bilge should be sprayed periodically with a protector to reduce the corrosive effects of the high humidity always present in these areas.
- Periodically check the bilge pumps for proper operation and clean debris from the strainers and float switches.
- Inspect all hoses, clamps and thru-hulls for leaks and tightness on a regular basis.
- Operate all thru-hull valves at least once a month to keep them operating properly.
- Operate all pumps at least once each month to verify operation and increase service life.
- Frequently test the automatic switches for the bilge pumps for proper operation. This is accomplished by rotating the knob on the side of the float switch until the pump starts. You can also use a garden hose to flood the bilge until the water level is high enough to activate the pump.

12.5 Engine & Fuel

Proper engine maintenance is essential to the proper performance and reliability of your outboard engines. Maintenance schedules and procedures are outlined in your engine owner's manual. They should be followed exactly.

If the boat is used in saltwater, flush the cooling system after each daily use. To flush the system when the boat is out of the water, follow the procedure outlined in your engine owner's manual.

Proper engine operation requires a good supply of clean, dry fuel. Improper marina fuel storage techniques, limited boat usage, etc. can cause the fuel to become contaminated.

The age of fuel can affect engine performance. Chemical changes occur as the fuel ages that can cause deposits and reduce the octane rating of the fuel. Severely degraded fuel can damage the engines and boat fuel tank and lines. Therefore, if your boat is not being run enough to require at least one full tank of fresh fuel a month, a fuel additive should be added to protect it from degradation. Your dealer or the engine manufacturer can provide additional information on fuel degradation and fuel stabilizers recommended for your engine.

In many states, most gasoline is blended with ethanol alcohol. Ethanol is a strong solvent and can absorb water during periods of storage. You should refer to the engine operating manual for information regarding alcohol blended fuels and how it affects the operation of your marine engines.



12.6 Drainage System

It is essential that the following items be done periodically to maintain proper drainage of your boat:

- Clean the cockpit drains with a hose to remove debris that can block water drainage.
- Flush all gravity drains with fresh water to keep them clean and free flowing.
- Operate the thru-hull valves once a month and service as required.

Notice:

All drains and pumps must be properly winterized before winter lay-up.

	CAUTION	
NEVER USE HARSH CHEMICAL DRAIN CLEANERS IN MARINE DRAIN SYSTEMS. PERMANENT DAMAGE TO THE HOSES AND FITTINGS MAY RESULT.		

NOTES

SEASONAL MAINTENANCE

14.1 Storage & Lay-up**Before Hauling:**

- Pump out the head and holding tank. Flush the holding tank using clean water and a deodorizer. Pump out the cleaning solution.
- The fuel tank should be left nearly full to reduce condensation that can accumulate in the tank. Allow enough room in the tank for the fuel to expand without leaking out the vent.
- The age of fuel can affect engine performance. Chemical changes occur as the fuel ages that can cause deposits and reduce the octane rating of the fuel. Severely degraded fuel can damage the engine and boat fuel tank and lines. Therefore, if your boat is not being run enough to require at least one full tank of fresh fuel a month, a fuel additive should be added to protect it from degradation. Operate the boat for at least 15 minutes after adding the additive to allow the treated fuel to reach the engine.

Your dealer or the engine manufacturer can provide additional information on fuel degradation and fuel additives recommended for your engine. For more recommendations for your specific area, check with your dealer.

- Drain water from the fresh water system.
- Consult the engine owner's manual for detailed information on preparing the engine for storage.

Lifting

It is essential that care be used when lifting your boat. Make sure the spreader bar at each sling is at least as long as the distance across the widest point of the boat that the sling will surround. Put the slings in position. The fore and aft slings should be tied together to prevent the slings from sliding on the hull.

**CAUTION**

BOATS CAN BE DAMAGED FROM IMPROPER LIFTING AND TRANSPORTING WITH FORK LIFTS. CARE AND CAUTION MUST BE EXERCISED WHEN TRANSPORTING A BOAT WITH A FORK LIFT. NEVER HOIST THE BOAT WITH A SUBSTANTIAL AMOUNT OF WATER IN THE BILGE.

SEVERE GEL COAT CRACKING OR MORE SERIOUS HULL DAMAGE CAN OCCUR DURING HAULING AND LAUNCHING IF PRESSURE IS CREATED ON THE GUNWALES (SHEER) BY THE SLINGS. FLAT, WIDE BELTING SLINGS AND SPREADERS LONG ENOUGH TO KEEP PRESSURE FROM THE GUNWALES ARE ESSENTIAL. DO NOT ALLOW ANYONE TO HAUL YOUR BOAT WHEN THE SPREADERS ON THE LIFT ARE NOT WIDE ENOUGH TO TAKE THE PRESSURE OFF THE GUNWALES.

Supporting The Boat For Storage

A trailer, elevating lift, well-made cradle or proper blocking is the best support for your boat during storage.

When storing the boat on a trailer for a long period:

- Make sure the trailer is large enough to properly support your boat and that it is rated to support the weight.
- Make sure the trailer is on a level surface and the bow is high enough so that water will drain from the bilge and cockpit.
- Make sure the engines are in the down position.
- The trailer must properly support the hull. The bunks and rollers should match the bottom of the hull and should not be putting pressure on the lifting strakes.
- Make sure the hitch is properly supported.
- Check the tires once each season. Add enough air for the correct amount of inflation for the tires as necessary.



Notice:

Read the owner's manual for the trailer for the correct amount of inflation for the tires.

Seasonal Maintenance

When storing the boat on a lift or cradle:

- The cradle must be specifically for boat storage.
- Make sure the cradle or lift is well supported with the bow high enough to provide proper drainage of the bilge and cockpit.
- Make sure the engines are in the down position.
- The cradle or lift must be in the proper fore and aft position to properly support the hull. When the cradle or lift is in the correct location, the bunks should match the bottom of hull and should not be putting pressure on the lifting strakes.

 **CAUTION** 

BOATS HAVE BEEN DAMAGED BY TRAILERS, LIFTS AND CRADLES THAT DON'T PROPERLY SUPPORT THE HULL. ALWAYS MAKE SURE THE BUNKS AND ROLLERS ARE ADJUSTED SO THEY ARE NOT PUTTING PRESSURE ON THE LIFTING STRAKES AND ARE PROVIDING ENOUGH SUPPORT FOR THE HULL. HULL DAMAGE RESULTING FROM IMPROPER CRADLE OR TRAILER SUPPORT IS NOT COVERED BY THE CREVALLE WARRANTY.

When supporting the boat with blocking:

- Make sure the boat is blocked on a level surface and the bow is high enough so that water will drain from the bilge and cockpit.
- Make sure the keel is supported with large, solid wood blocks in at least three points.
- Use at least two heavy duty jacks on each side of the hull and make sure the boat is level from side to side. The jacks must be on a solid surface like packed gravel, concrete or pavement. All of the supports must be set up properly to prevent the boat from shifting while it is in storage.

Preparing The Boat For Storage:

- Remove the bilge drain plug, if installed.
- Thoroughly wash the fiberglass exterior, especially the antifouling portion of the bottom. Remove as much marine growth as possible. Lightly wax the exterior fiberglass components.
- Remove all oxidation from the exterior hardware and apply a light film of moisture displacing lubricant, wax or a metal protector.

- Remove propellers and grease the propeller shafts using light waterproof grease.
- Remove the batteries and store in a cool place. Clean using clear, clean water. Be sure the batteries have sufficient water and clean terminals. Keep the batteries charged and safe from freezing throughout the storage period.

Notice:

Refer to the Electrical System chapter, for information on the maintenance of the AC and DC electrical systems.

- Coat all faucets and exposed electrical components in the cabin and cockpit with a protecting oil.
- Clean out, totally drain and completely dry the fish boxes, coolers, sinks and livewells.
- Thoroughly clean the interior of the boat. Vacuum all carpets and dry clean drapes and upholstery.
- Remove cushions and open as many locker doors as possible. Leaving as many of these areas open as possible will improve the boat's ventilation during the storage period.

Notice:

It is recommended that a mildew preventer be hung in the head compartment before it is closed for storage.

- Clean the exterior upholstery with a good vinyl cleaner and dry thoroughly. Spray the weather covers and boat upholstery with a spray disinfectant. Enclosed areas such as the shower basin, storage locker areas, etc. should also be sprayed with this disinfectant.

14.2 Freshwater System Winterizing Fresh Water System

The entire fresh water system must be completely drained. Disconnect all hoses, check valves, etc. and blow all the water from the system. Make sure the filters and fresh water tank are completely drained. Use only very low air pressure when doing this to prevent possible system damage. Because of the check valve mechanism built in the pump, blowing the lines will not remove the water from the fresh water pump. Remove the inlet and outlet hoses on the pump. Turn the pump on and allow it to pump out any remaining water... about a cupful.

A recommended alternative to the above-mentioned procedure is the use of commercially available non toxic, fresh water system antifreeze. After draining the fresh water tank, lines and filters, pour the antifreeze mixture into the fresh water tank, prime and operate the pump until the mixture flows from all fresh water faucets and the hardtop shower. Be sure to open all water faucets, including the fresh water washdown hose and flush the toilet several times. Make sure antifreeze has flowed through all of the fresh water drains.

For additional information refer to the Fresh Water System and Drainage Systems chapters.

14.3 Raw Water System Winterizing

The raw water washdown and seawater supply pumps and systems must be completely drained and winterized using the following procedures.

Sea Chest & baitwell Water Supply System

The sea chest and baitwell water supply system require the following procedure to be properly winterized with boat out of the water.

1. Open the thru-intake valves to drain all water from the intake lines and sea chest.
2. Remove and clean the strainer screen in the scoop for the primary supply hose. Reassemble the strainer.
3. Close the intake valves and fill the sea chest with potable water antifreeze.
4. Run the baitwell pumps one at a time until the antifreeze solution is visible at the baitwell supply valves. Open the drain valves and continue to run the pump until antifreeze has flowed through the baitwell drain thru-hull fittings. Refill the sea chest as required to accomplish this.

Raw Water Washdown System

Open the thru-hull valve, disconnect all hoses and blow the water from the system. Use only very low air pressure when doing this to prevent possible system damage. Because of the check valve mechanism built in the raw water washdown pump, blowing the lines will not remove the water from the raw water pump. Remove the inlet and outlet hoses on the pump. Turn the pump on and allow it to pump out any remaining water... about a cupful.

A recommended alternative to the above-mentioned procedure is the use of potable water system antifreeze. If potable water antifreeze is used, pour the mixture into a pail and put the raw water pump intake line into the solution. Run the pump until the antifreeze solution is visible at all raw water faucets and discharge fittings. Be sure antifreeze has flowed through all of the raw water drains.

Fishbox Pump Out System

Run the fish box pumps until all the water is removed from the fish boxes and the pump. Then pour potable water antifreeze in each fish box and activate the pumps until antifreeze is visible at the discharge thru-hull fittings. To avoid damage to the pumps, be careful not to run the pumps dry for more than a few seconds.

Marine Toilet

The marine toilet must be properly winterized by following the manufacturer's winterizing instructions in the marine toilet owner's manual. Drain the intake and discharge hoses completely using low air pressure if necessary. The head holding tank and overboard discharge pump must be pumped dry and one gallon of potable water antifreeze poured into the tank through the deck waste pump out fitting. After the antifreeze has been added to the holding tank, open the overboard discharge valve and activate the overboard macerator pump until the antifreeze solution is visible at the discharge thru-hull.

Notice:

Make sure you follow the marine toilet manufacturer's winterizing instructions exactly.

The freshwater supply line to the toilet must be properly winterized when winterizing the fresh water system.

Bilge

Coat all metal components, wire busses and connector plugs in the bilge with a protecting oil. It is also important to protect all strainers, seacocks and steering components. The bilge pumps and bilge pump lines must be completely free of water and dried out when the boat is laid-up for the winter in climates where freezing occurs. Compartments in the bilge that will not drain completely should be pumped out and then sponged until completely free of water. Dry the hull bilge and self-bailing cockpit troughs. Water freezing in these areas could cause damage.

Seasonal Maintenance

Outboard Engines

The engines should be flushed with fresh water for at least 15 minutes prior to winter storage. This will remove salt, sand and other contaminants that can damage the engine. It is also important to "Fog" the cylinders, change the gear and engine oil, coat each engine with a protector, wax the exterior and properly store and charge the batteries. You should refer to the engine owner's manual or contact your dealer for specific instructions on winterizing your engines.

Notice:

Properly winterize the engines and fuel system by following the engine manufacturer's winterizing procedures located in your engine owner's manuals or contact an Crevalle dealer.

Hardtop

It is imperative that all drain holes in the legs are open and that the legs are completely free of water. Remove the canvas and thoroughly clean and store in a safe, dry place. Remove all electronics. Coat all wire connectors and bus bars in the helm compartment with a protecting oil.

Clean the aluminum frame with soap and water and dry thoroughly. Apply an aluminum metal protector to the entire frame on anodized aluminum to reduce corrosion and pitting. Apply an automotive or boat wax to powder coated aluminum to protect it during storage periods.



CAUTION



ALWAYS MAKE SURE THE LEG DRAIN HOLES ARE CLEAR WHEN THE BOAT IS LAID UP FOR THE WINTER. WATER TRAPPED INSIDE THE HARDTOP LEGS COULD FREEZE AND CAUSE THE LEGS TO SPLIT.

Special Notes Prior To Winter Storage

If the boat will be in outside storage, properly support a storage cover and secure it over the boat. It is best to have a frame built over the boat to support the canvas. It should be a few inches wider than the boat so the canvas will clear the rails and allow passage of air. If this cover is fastened too tightly there will be inadequate ventilation and this can lead to mildew, moisture accumulation, etc. It is essential to fasten the canvas down securely so that the wind cannot remove it or cause chafing of the hull superstructure. Do not store the boat in a damp storage enclosure. Excessive dampness can cause electrical problems, corrosion and excessive mildew.

Whenever possible, do not use the Bimini top or convertible top canvas in place of the winter storage cover. The life of these canvases may be significantly shortened if exposed to harsh weather elements for long periods.



CAUTION



PLACING AN ELECTRIC OR FUEL BURNING HEATING UNIT IN THE BILGE AREA CAN BE POTENTIALLY HAZARDOUS AND IS NOT RECOMMENDED.

Proper storage is very important to prevent serious damage to the boat. If the boat is to be stored indoors, make sure the building has enough ventilation. It is very important that there is enough ventilation both inside the boat and around the boat.

Notice:



If the boat is to be stored indoors or outdoors, open all interior drawers, clothes lockers, cabinets and doors a little. If possible, remove the upholstery, mattresses, clothing and rugs. Then hang a commercially available mildew protector in the interior compartments.

14.4 Recommissioning

	WARNING	
DO NOT OPERATE THE BOAT UNLESS IT IS COMPLETELY ASSEMBLED. KEEP ALL FASTENERS TIGHT. KEEP ADJUSTMENTS ACCORDING TO SPECIFICATIONS.		

Notice:

It is important and recommended that the fitting out procedure for the marine gear be done by a qualified service person. Read the engine owner's manual for the recommended procedure.

	CAUTION	
BEFORE LAUNCHING THE BOAT, MAKE SURE THE HULL AND SEA CHEST DRAIN PLUGS ARE INSTALLED AND TIGHT.		

Reactivating The Boat After Storage:

- Charge and install the batteries.
- Install the drain plug in the hull.
- Check the engines for damage and follow the manufacturer's instructions for recommissioning.
- Check the mounting bolts for the engines to make sure they are tight.
- Perform all routine maintenance.
- Check all hose clamps for tightness.
- Pump the antifreeze from the fresh and raw water systems and flush several times with fresh water.
- Check and lubricate the steering system.
- Clean and wash the boat.
- Install all upholstery, cushions and canvas.

After Launching:

- Carefully inspect engine bolts and other transom mounted equipment for leaks.
- Open the sea chest inlet valves and carefully check the sea chest and baitwell systems for leaks. Operate each baitwell pump one at a time checking for leaks and proper operation.
- Open the raw water washdown thru-hull valve and operate the washdown system. Check for leaks and proper operation.
- Check all thru-hull fittings, valves and hoses for leaks.
- Check bilge pump manual and automatic switches.
- When each engine starts, check the cooling system port below the engine cowling for a strong stream of water. This ensures that the cooling pump is operating.
- Carefully monitor the gauges and check for leakage and abnormal noises.
- Operate the boat at slow speeds until the engine temperature stabilizes and all systems are operating normally.

NOTES

Crevalle 33 Seastar DCM Electrical Systems

Viewing Your Electronic Drawing Set:

This electronic drawing set is rendered for electronic viewing giving an enhanced ability to read as the drawings are depicted in layered views that can be turned ON and OFF. Adobe Acrobat Reader is recommended for best view-ability.

When using any Adobe PDF viewer you can turn "Layers" on and off using the "Layers Toolbar". Turn Layers On and OFF by selecting the EYE Icon. An Eye missing means the layer is not visible or "turned off".

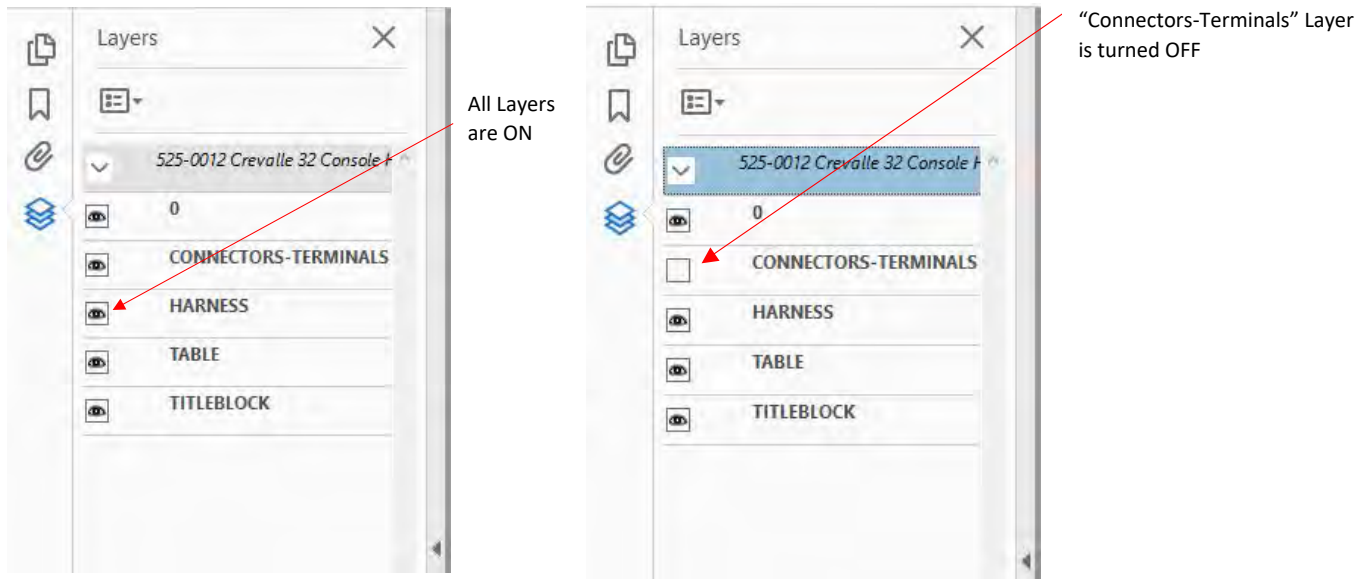

You may have to access the Layers Menu to limit the layers selection to only show the layers of the current page. When printing, a layer will only print if the layer is selected for viewing. For best results print on "B" (17"x11") or larger paper size.

CREVALLE 33- SEASTAR DCM

DCM ASSY (CONSOLE)

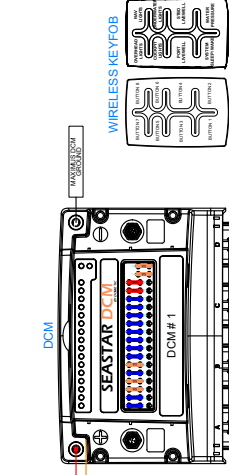
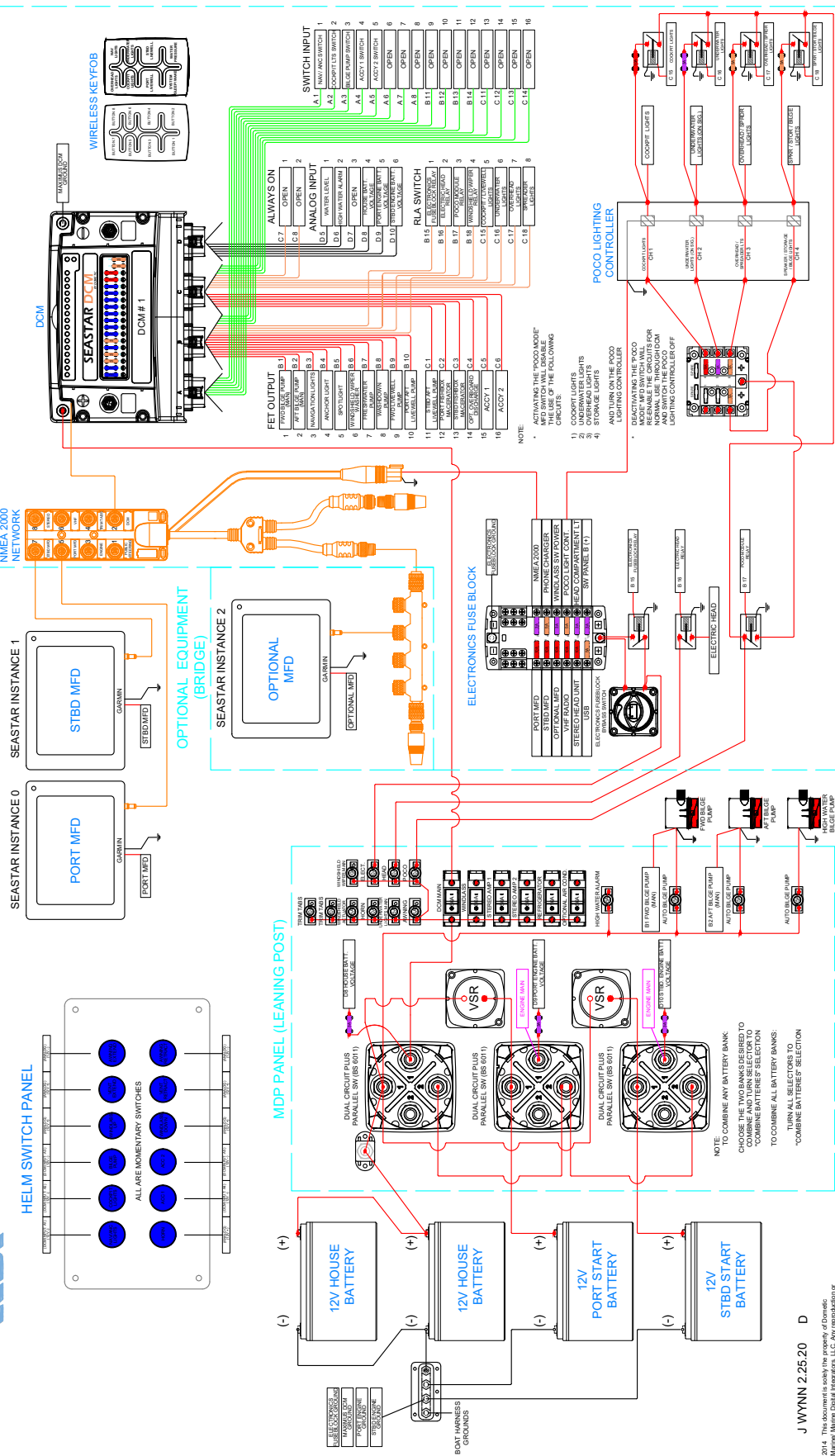
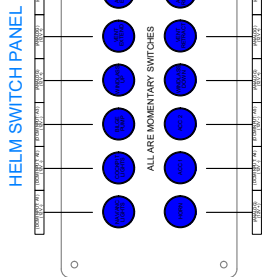

- | FET OUTPUT | |
|------------|-----------------|
| 1 | WATER PUMP |
| 2 | PORT BLUZE PUMP |
| 3 | STBD BLUZE PUMP |
| 4 | ANCHOR LIGHT |
| 5 | SPOT LIGHT |
| 6 | WATER WALKER |
| 7 | WATER WALKER |
| 8 | WATER WALKER |
| 9 | WATER WALKER |
| 10 | WATER WALKER |
| 11 | WATER WALKER |
| 12 | WATER WALKER |
| 13 | WATER WALKER |
| 14 | WATER WALKER |
| 15 | WATER WALKER |
| 16 | WATER WALKER |
-
- | ANALOG INPUT | |
|--------------|-------------|
| 1 | WATER LEVEL |
| 2 | WATER ALARM |
| 3 | WATER ALARM |
| 4 | WATER ALARM |
| 5 | WATER ALARM |
| 6 | WATER ALARM |
| 7 | WATER ALARM |
| 8 | WATER ALARM |
| 9 | WATER ALARM |
| 10 | WATER ALARM |
| 11 | WATER ALARM |
| 12 | WATER ALARM |
| 13 | WATER ALARM |
| 14 | WATER ALARM |
| 15 | WATER ALARM |
| 16 | WATER ALARM |

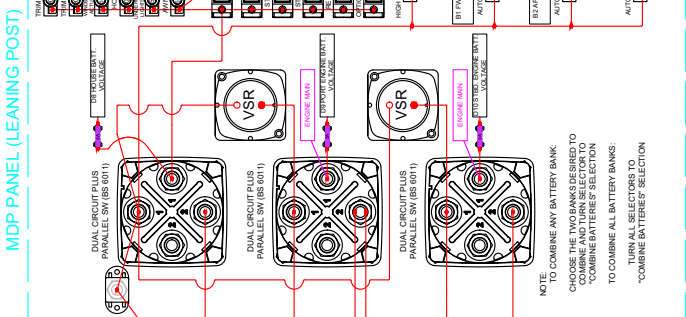
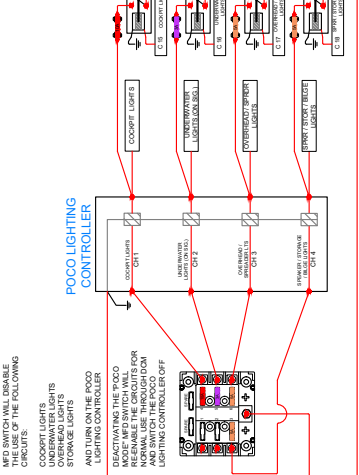

NOTE:
TO COMBINE ANY BATTERY BANK,
CHOOSE THE TWO BANKS DESIRED TO
COMBINE AND TURN SELECTOR TO
"COMBINE BATTERIES" SELECTION
TO COMBINE ALL BATTERY BANKS,
TURN ALL SELECTORS TO
"COMBINE BATTERIES" SELECTION

J WYNN 2.25.20 D

2014. This document is the property of Marine Digital Integrators, LLC. Any reproduction or distribution, either electronic or hard copy, of this document without the written consent of Marine Digital Integrators, LLC, is forbidden.

Seastar DCM

CREVALLE 33 DCM/ WET SOUNDS ASSEMBLY (SHEET 1 OF 2) (LAYOUT)

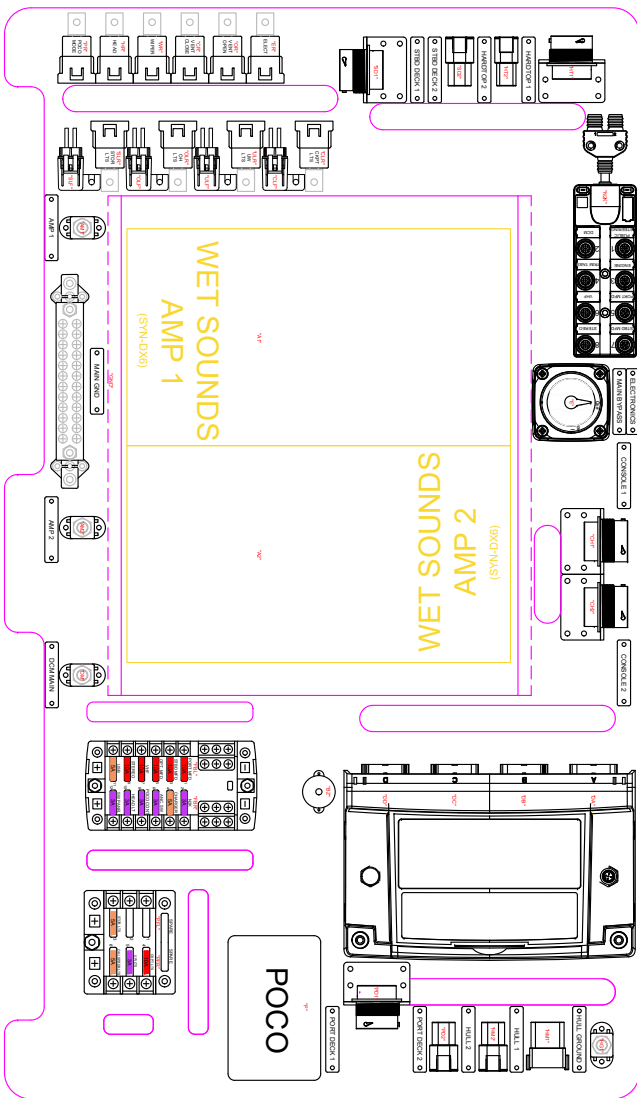

2014 This document is solely the property of Dometic Marine/ Marine Digital Integrators, LLC. Any reproduction or distribution, either electronic or hard copy, of this document whether total or partial without the written consent of Marine Digital Integrators, LLC, is forbidden.

Rev. 1 Notes		1. See Detail Equipments for SNN-DX8-855 (Item 1) behind the door		DRAWN BY: LYVNN		DATE: 11/27/18		SCALE: N/A		SHEET 1 of 2	
2. Change "Poco" light to accommodate light re-plotting		SEE NOTES		J WYNN		NONE		1		SHEET 1 of 2	
3. Change "Poco" light to accommodate light re-plotting		NITRAL DESIGN		C DOUX		NONE		0		SHEET 1 of 2	
4. Change "Poco" light to accommodate light re-plotting		REV. BY/DATE		REV. BY/DATE		ECON		REV		SHEET 1 of 2	
5. Change "Poco" light to accommodate light re-plotting		REV. BY/DATE		REV. BY/DATE		ECON		REV		SHEET 1 of 2	

DCM/ Wet Sounds Assembly 1



CREVALLE 33 DCM/ WET SOUNDS ASSEMBLY (SHEET 2 OF 2) (WIRING)

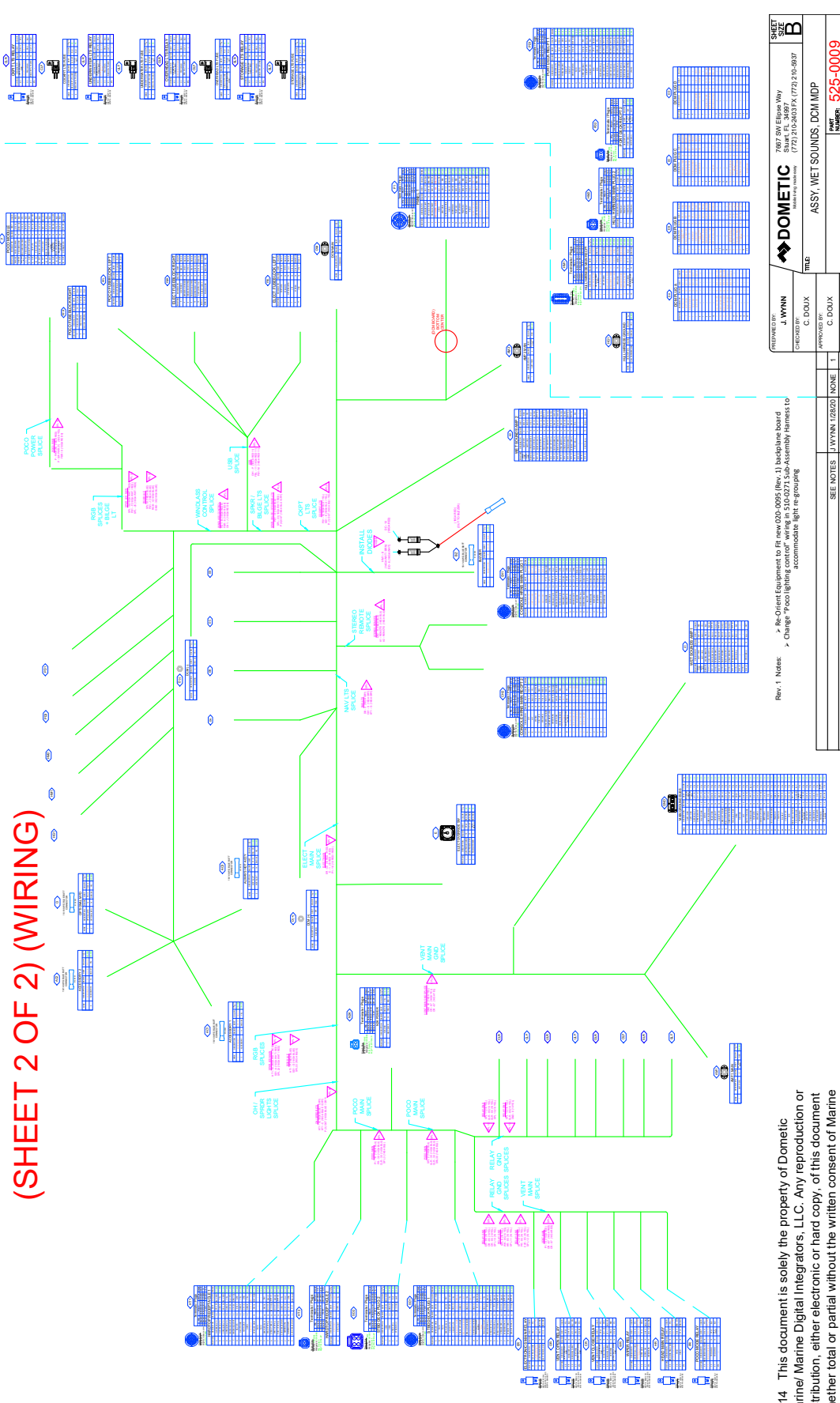

PREPARED BY	J. WINN	7807 SW Elsie Way Suite #1, 38997 Tallahassee, Florida 32317 (772) 210-9837	SHEET	B
CHECKED BY	C. DOUX		TITLE	ASSY, WET SOUNDS, DCM MDP
APPROVED BY	C. DOUX		PART NUMBER	525-0009
DATE			DRAWN BY	J. WINN
			DATE	11/15/10
			SCALE	AS SHOWN

Rev. 1 Notes:
 * Re-Orient Equipment to fit new Q00-0095 (Rev. 1) backplane board
 * Change "Foco lighting control" wiring in 510-0271 Sub-Assembly Harness to accommodate light re-grouping

REV	BY	DATE	ECN	REV	DESCRIPTION
1	J. WINN	11/15/10	0	1	INITIAL DESIGN
0	C. DOUX		0	0	SEE NOTES

2014 This document is solely the property of Dometic Marine/ Marine Digital Integrators, LLC. Any reproduction or distribution, either electronic or hard copy, of this document whether total or partial without the written consent of Marine Digital Integrators, LLC, is forbidden.

DCM/ Wet sounds Assembly 2



CREVALLE 33 DCM/ JL AUDIO ASSEMBLY (SHEET 1 OF 2)

LAYOUT / OVERVIEW

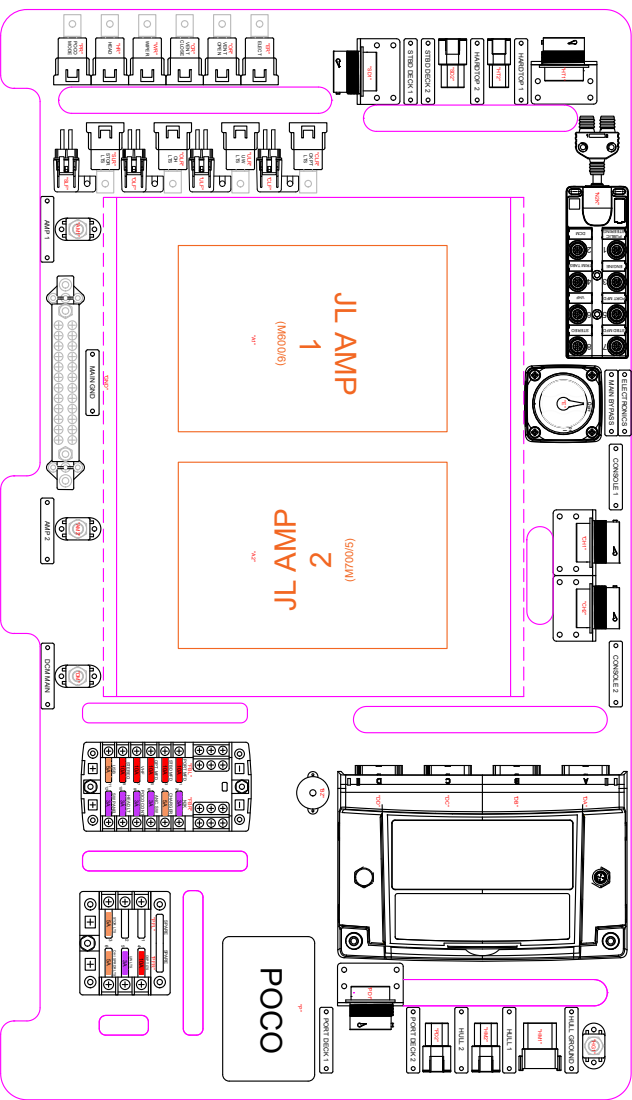

2014 This document is solely the property of Dometic Marine/ Marine Digital Integrators, LLC. Any reproduction or distribution, either electronic or hard copy, of this document whether total or partial without the written consent of Marine Digital Integrators, LLC, is forbidden.

REV. 1	NOTE	1. Re-Orient Equipment to fit new 030-0095 (Rev. 1) battery board	2. Change "Poco lighting control" wiring as 510-0272-518 Assembly harness to accommodate light re-pooling
DESIGNER	J. WYNN	APPROVER	C. DOUX
INITIAL DESIGN	WYNN/J1020	REV. R1/DATE	ECM
REVISION DESCRIPTION	REV. R1/DATE	ECM	REV.
DOMETIC 7847 SW Ellison Way Suite R, 3009 Fort Lauderdale, FL 33309 (754) 350-5900 FAX (754) 210-9807		SHEET B	
ASSY, JL DCM MDP		PART NUMBER: 525-0008	
DRAWN BY: WYNN		DATE: 11.13.13	

DCM/ JL Audio Assembly 1

CREVALLE 33 DCM/ JL AUDIO ASSEMBLY (SHEET 2 OF 2) (WIRING)

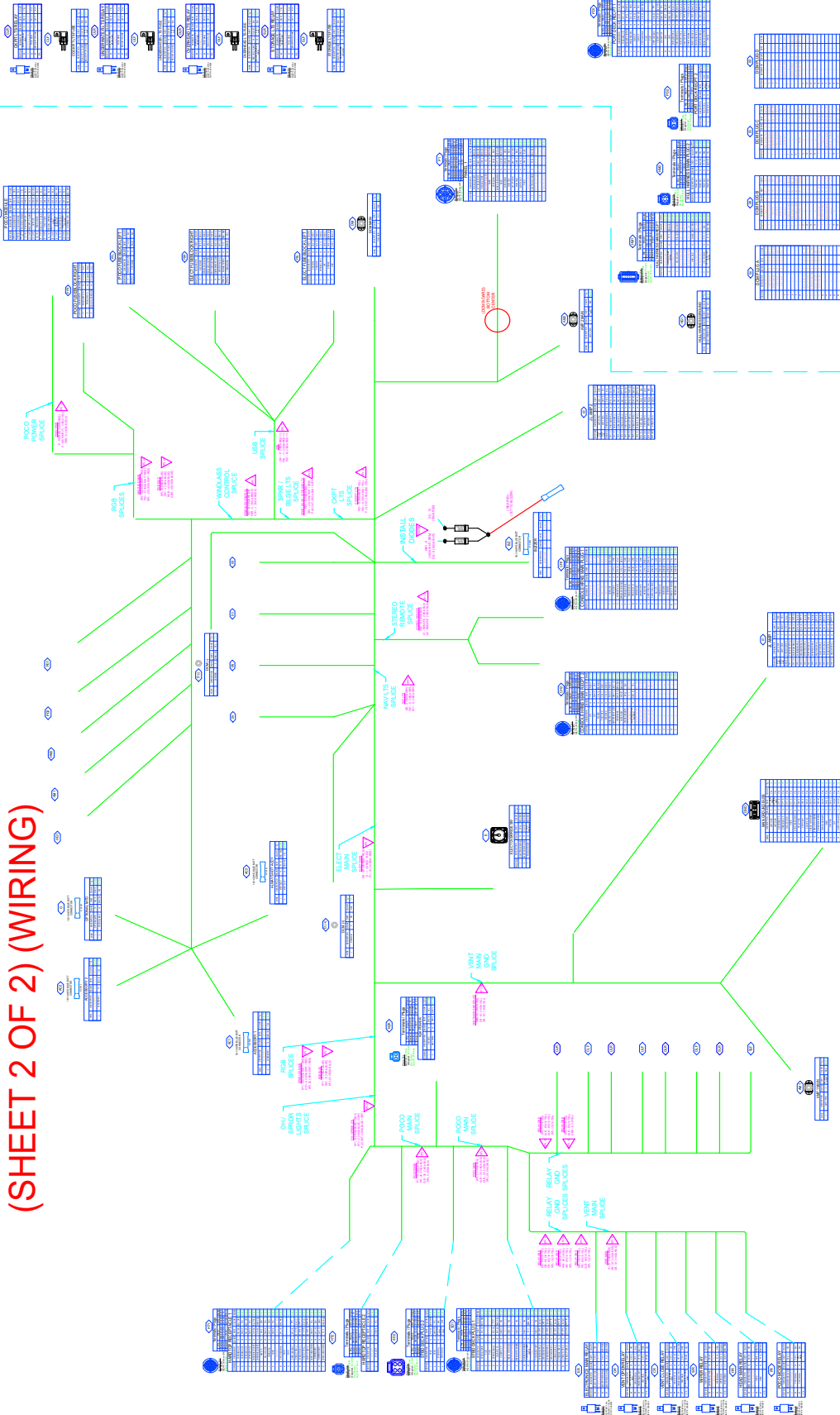

DESIGNED BY: J.WYNN	7887 SW Elise Way Tualatin, OR 97063 (773) 212-2403 FAX (773) 210-5837
CHECKED BY: C.DOLUX	
APPROVED BY: C.DOLUX	

FILE: ASSY_JL_DCM MDP
PART NUMBER: 525-0008
REV. #/FN: 1/2

REVISED BY: J.WYNN	NOISE 1
INITIAL DESIGN: J.WYNN	NOISE 0
REVISION DESCRIPTION: REV BY/DATE	ECON REV

Rev. 1 Notes:

- > Re-Orient Equipment to fit new QD-0095 (Rev. J) backbone board
- > Change POCO lighting control wiring in 310-0272310-Assembly harness to accommodate light re-grouping

SEE NOTES: J.WYNN 7/26/20
INITIAL DESIGN: J.WYNN 1/7/20
REVISION DESCRIPTION: REV BY/DATE

2014 This document is solely the property of Dometic Marine/ Marine Digital Integrators, LLC. Any reproduction or distribution, either electronic or hard copy, of this document whether total or partial without the written consent of Marine Digital Integrators, LLC, is forbidden.



CREVALLE 33 MDP BATTERY SW PANEL

FRONT VIEW

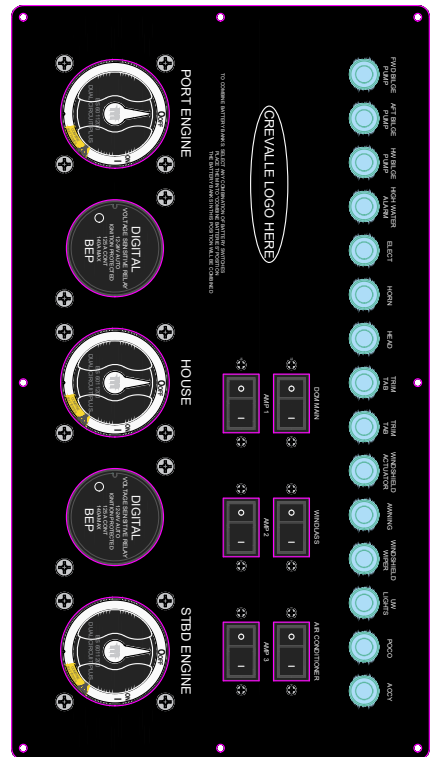

WIRING INSTRUCTION

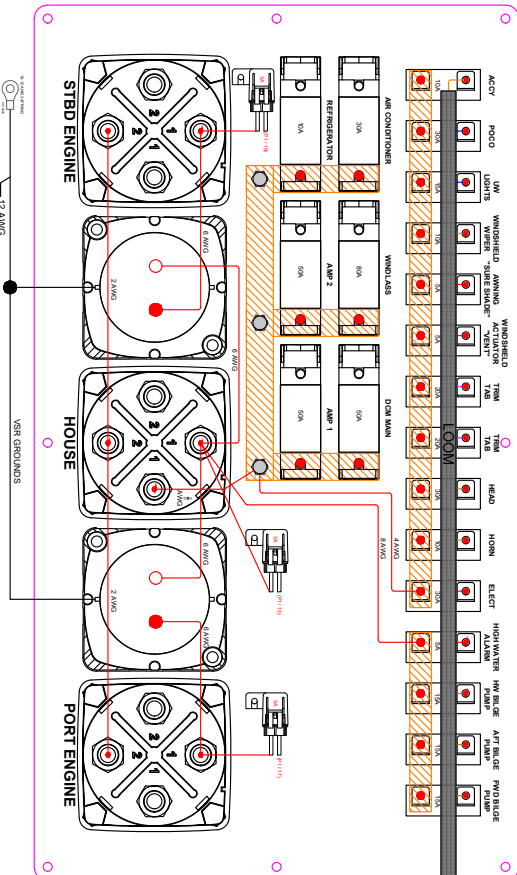

BATT MDP TO DCM MDP CONNECTION

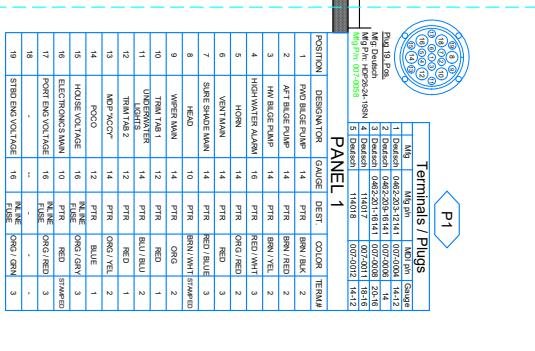

2014 This document is solely the property of Dometic Marine/ Marine Digital Integrators, LLC. Any reproduction or distribution, either electronic or hard copy, of this document without the written consent of Marine Digital Integrators, LLC, is forbidden.

DRAWN BY: J. WYMAN
 CHECKED BY: R. HENRICHSEN
 APPROVED BY: C. DOUX
 DATE: 07/23/2013
 TITLE: ASSY. PANEL, MDP BATT SW
 PART NO: 525-0007
 REV: 1
 SHEET: 1 OF 1

MDP Battery Switch Panel



CREVALLE 33 PORT DECK HARNNESS

- * HARNNESS CONTAINS NO SPLIT LOOM
- * ALL SPLICES MUST BE STAGGERED
- * FROM ONE ANOTHER
- * LABEL EACH CUSTOMER CONNECTION

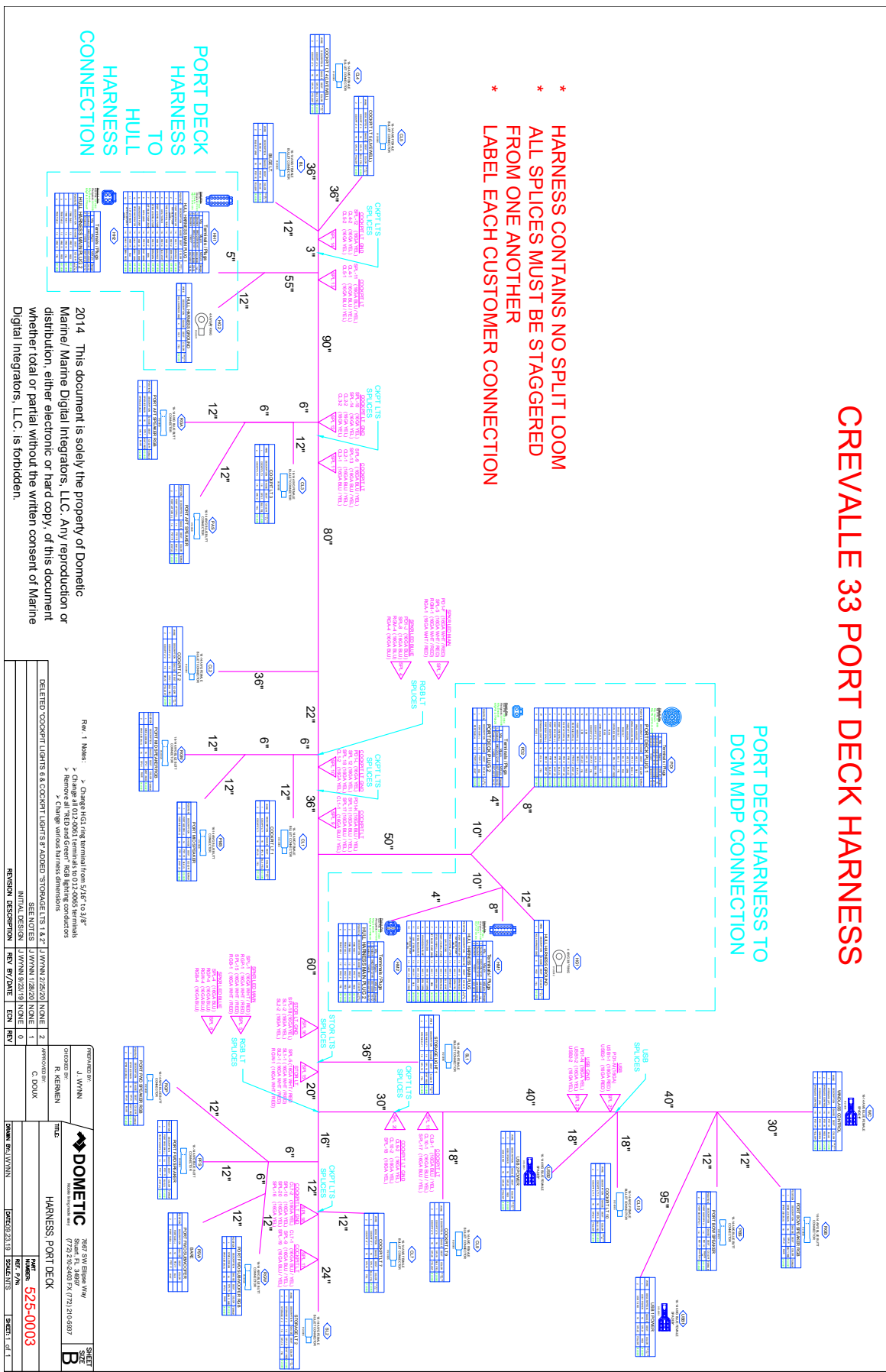

2014 This document is solely the property of Dometic Marine/ Marine Digital Integrators, LLC. Any reproduction or distribution, either electronic or hard copy, of this document whether total or partial without the written consent of Marine Digital Integrators, LLC, is forbidden.

Rev. 1 Notes:

- > Change HGL ring terminals from 7/16" to 3/8"
- > Change all 012, 0061 terminals to 012, 0065 terminals
- > Remove all RED and Green Red igniting conductors
- > Change wire sizes for all harnesses

REVISION	DATE	BY	DESCRIPTION
1	11/14/14	J. WYMAN	ORIGINAL
2	01/15/15	R. HENRISEN	CHANGE HGL TERMINALS TO 3/8"
3	01/15/15	C. DOUX	REMOVE RED AND GREEN WIRE
4	01/15/15	C. DOUX	CHANGE WIRE SIZES
5	01/15/15	C. DOUX	REMOVE RED AND GREEN WIRE
6	01/15/15	C. DOUX	CHANGE WIRE SIZES

DESIGNED BY	J. WYMAN	DATE	11/14/14
CHECKED BY	R. HENRISEN	DATE	01/15/15
APPROVED BY	C. DOUX	DATE	01/15/15

COMPANY	DOMETIC	ADDRESS	3845 SW 58th Way, Davie, FL 33097
PHONE	754-943-0000	FAX	754-943-0000
EMAIL	SALES@DOMETIC.COM	WEBSITE	WWW.DOMETIC.COM
PROJECT	DOMETIC 33 PORT DECK HARNNESS	DRAWING NO.	140523-23-10
SHEET	B	TOTAL SHEETS	1

Port Deck Harness



CREVALLE 33 STBD DECK HARNESS

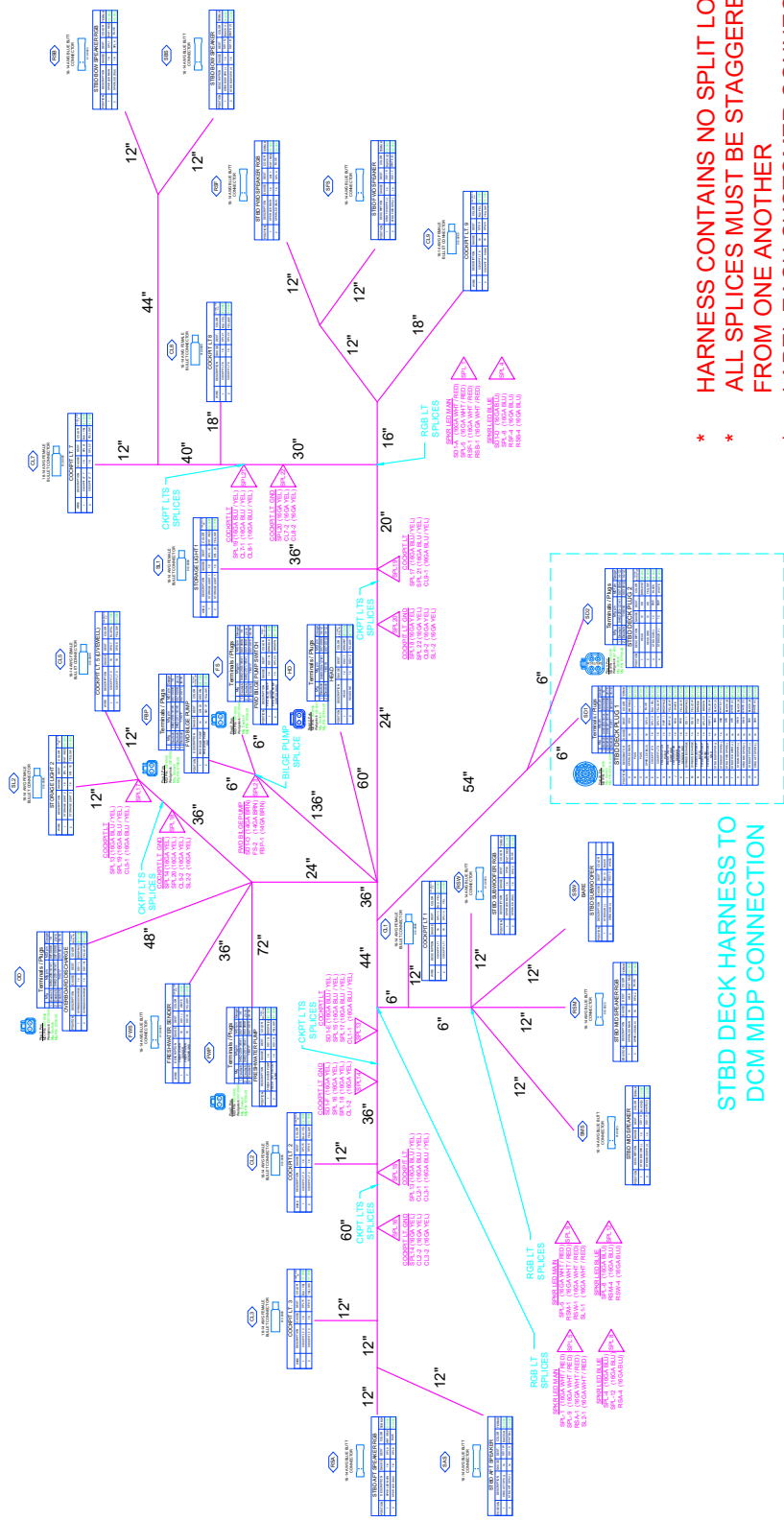

* HARNESS CONTAINS NO SPLIT LOOM
 * ALL SPLICES MUST BE STAGGERED
 * FROM ONE ANOTHER
 * LABEL EACH CUSTOMER CONNECTION

STBD DECK HARNESS TO
 DCM MDP CONNECTION

Rev. 1 Notes:

- Change all 012-0061 terminals to 012-0065 terminals
- Remove all "Red and Green" RGB lighting conductors
- Adapt "Red and Green" RGB lighting conductors to "Red/Blue" conductors
- Add 012-0065 Deutsch Connector to "Red/Blue"

REV	DATE	BY	DESCRIPTION
1		J. WYNN	INITIAL DESIGN
2		J. WYNN	REVISED TO ADD "Red and Green" RGB lighting conductors
3		J. WYNN	REVISED TO ADAPT "Red and Green" RGB lighting conductors to "Red/Blue" conductors
4		J. WYNN	REVISED TO ADD 012-0065 Deutsch Connector to "Red/Blue"

PREPARED BY	J. WYNN	DATE	7/31/2014
CHECKED BY	CHRIS KERWEN	DATE	8/20/2014
APPROVED BY	C. DOUX	DATE	12/16/2014

7807 SW Europa Way
 Suite 18, 38997
 (772) 313-9317 (772) 210-9878
DOMETIC
 Integrating Marine Electronics

TITLE: HARNESS STBD DECK
 PART NUMBER: 525-0004
 DRAWN BY: J. WYNN
 PARTS/ISSUED BY: M. BROWN

SHEET 1 OF 1

2014 This document is solely the property of Dometic Marine/ Marine Digital Integrators, LLC. Any reproduction or distribution, either electronic or hard copy, of this document whether total or partial without the written consent of Marine Digital Integrators, LLC, is forbidden.

Starboard Deck Harness



CREVALLE 33 HARDTOP HARNESS

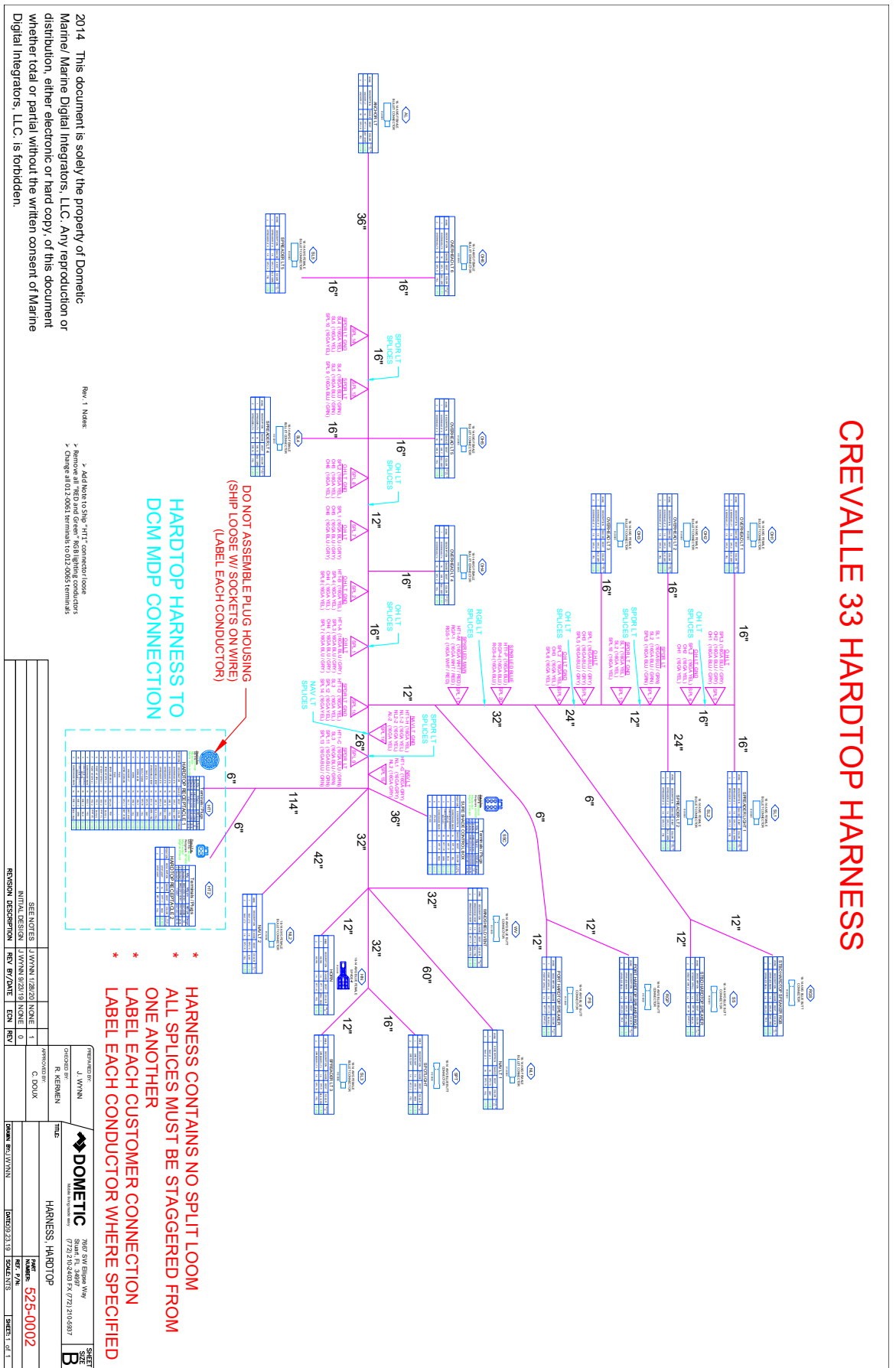

2014 This document is solely the property of Dometic Marine/ Marine Digital Integrators, LLC. Any reproduction or distribution, either electronic or hard copy, of this document whether total or partial without the written consent of Marine Digital Integrators, LLC, is forbidden.

Rev. 1 Notes:
 > Add Note to Ship "HT" connector house
 > Remove #178 and #179 "6638 lighting conductors"
 > Change #1012-0061 terminals to 012-0062 terminals

Hardtop Harness



CREVALLE 33 CONSOLE HARNESS

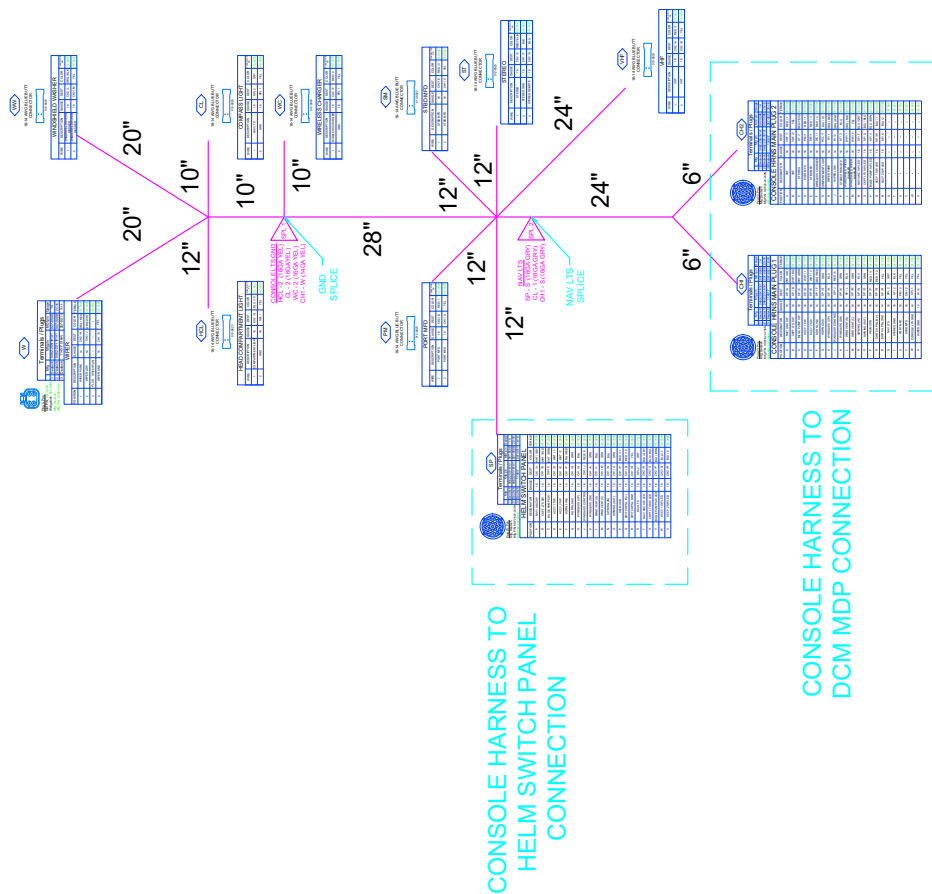

* HARNESS CONTAINS NO SPLIT LOOM
 * ALL SPLICES MUST BE STAGGERED FROM ONE ANOTHER
 * LABEL EACH CUSTOMER CONNECTION

2014 This document is solely the property of Dometic Marine/ Marine Digital Integrators, LLC. Any reproduction or distribution, either electronic or hard copy, of this document whether total or partial without the written consent of Marine Digital Integrators, LLC, is forbidden.

REVIEWED BY:	J. WYNN	DATE:	7/23/2014
DESIGNED BY:	B. KERWEN	DATE:	7/23/2014
APPROVED BY:	C. DOUX	DATE:	7/23/2014
TITLE:	HARNESS, CONSOLE		
DRAWN BY:	J. WYNN	DATE:	7/23/2014
PART NUMBER:	525-0012		
REV. 1 OF 1	SHEET 1 OF 1		

REVISION DESCRIPTION	REV	BY/DATE	ECN	REV
	0			

Console Harness



CREVALLE 33 DCM HELM SWITCH PANEL

OVERVIEW

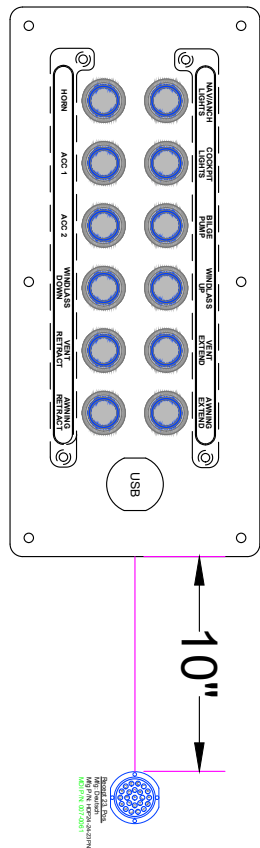

WIRING

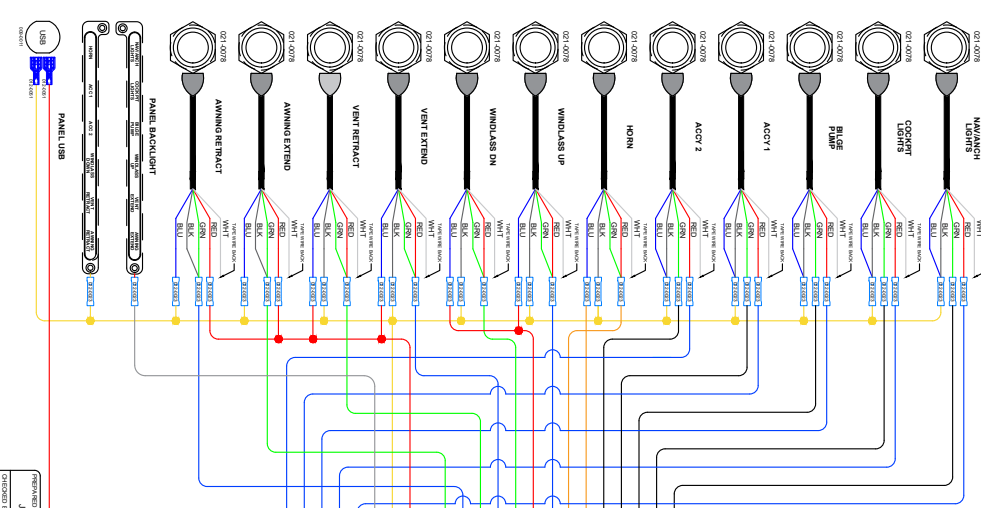

HELM SWITCH PANEL TO
CONSULE HARNESS
CONNECTION

POSITION	DESCRIPTION	GAUGE	DEST.	COLOR	TERMINAL
A	NAV/ANC SW	16		WHT/GRN	007-0007
B	CPRT LIS SW	16		WHT/BLU	007-0007
C	BLCF PUMP SW	16		WHT/BRN	007-0007
D	ACVY 1 SW	16		WHT/1	007-0007
E	ACVY 2 SW	16		WHT/2	007-0007
F	HORNLINE	14		ORG/BRN	007-0005
G	HORN LOAD	14		ORG	007-0005
H	WINDLASS (UP)	16		BLU	007-0007
J	WINDLASS CONTROL	16		RED/6	007-0007
K	WINDLASS (DN)	16		GRN	007-0007
L	WIND VENT (C)	16		BLU	007-0007
M	WIND VENT (I)	16		GRN	007-0007
N	AMING (IN)	16		BLU	007-0007
O	AMING (OUT)	16		GRN	007-0007
P	HELM USB	16		RED/11	007-0007
Q	SWITCHING GND	14		RED/12	007-0007
R	SWITCHING GND	14		YES	007-0005
S	NAV LIS	16		GRN	007-0007
T	NAV/ANC SW LED	16		BLU/GRN	007-0007
U	CPRT LIS SW LED	16		BLU/BLU	007-0007
V	BLCF PUMP SW LED	16		BLU/BRN	007-0007
W	ACVY 1 SW LED	16		BLU/1	007-0007
X	ACVY 2 SW LED	16		BLU/2	007-0007

2014 This document is solely the property of Dometic Marine/ Marine Digital Integrators, LLC. Any reproduction or distribution, either electronic or hard copy, of this document whether total or partial without the written consent of Marine Digital Integrators, LLC, is forbidden.

REVISIONS BY:	J. WYMAN	CHANGED BY:	C. DOUX
APPROVED BY:	C. DOUX	APPROVED BY:	C. DOUX
TITLE:	PANEL, HELM SW, DCM	DATE:	525-0006
DATE:	08/11/13	SHEET:	of 1

DOMETIC Marine Electronics
 2740 SW Ellison Way
 Shreve, LA 70587 (713) 219-0607
 1723 S. Highway 171, Shreve, LA 70587

Helm Switch Panel



CREVALLE 33 SPEAKER CONNECTOR HARNESS KIT

(510-0259) JL SPKR ADAPT HRNS QTY: 10

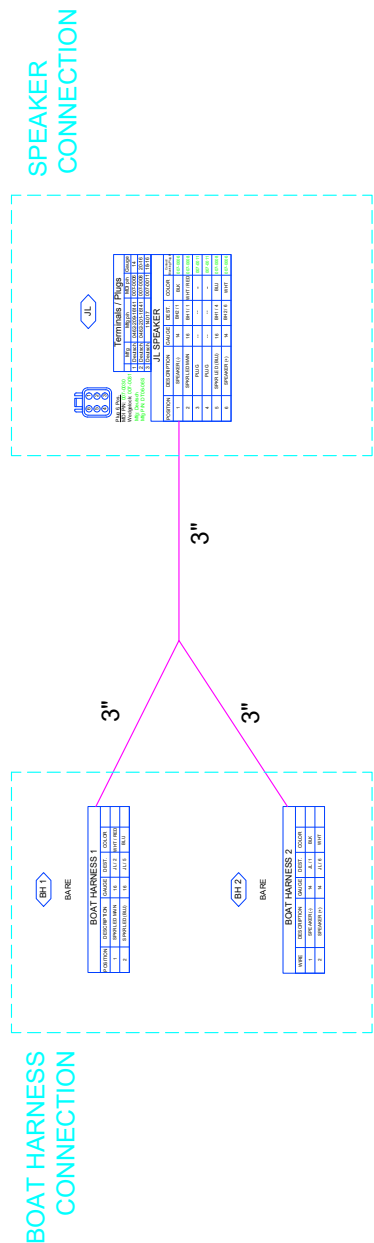

(510-0260) JL SUB ADAPT HRNS QTY: 2

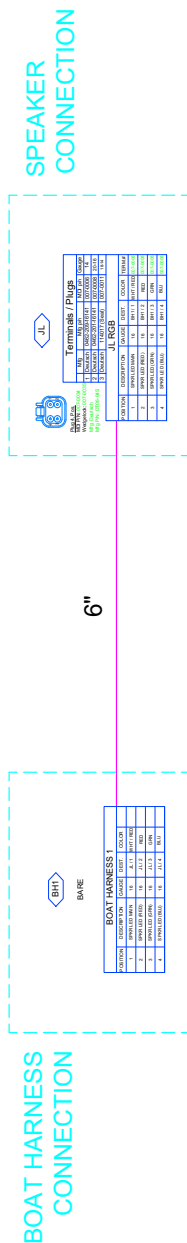

- * HARNES CONTAINS NO SPLIT LOOM
- * LABEL EACH CUSTOMER CONNECTION

2014 This document is solely the property of Dometic Marine/ Marine Digital Integrators, LLC. Any reproduction or distribution, either electronic or hard copy, of this document whether total or partial without the written consent of Marine Digital Integrators, LLC, is forbidden.

DESIGNED BY J. WYNN	7807 SW Elgin Way Buckle, FL 38907 (772) 210-9977	SHEET B
CHECKED BY K. KERNEN	DATE 02/21/14	REV 0
APPROVED BY C. DOUX	TITLE HARNES SPEAKER CONN	PART NUMBER 525-0010
DATE 02/21/14	REV 0	SHEET 1 OF 1

Speaker Connector Harness Kit

CREVALLE 33 TRIM TAB INTERFACE HARNESS

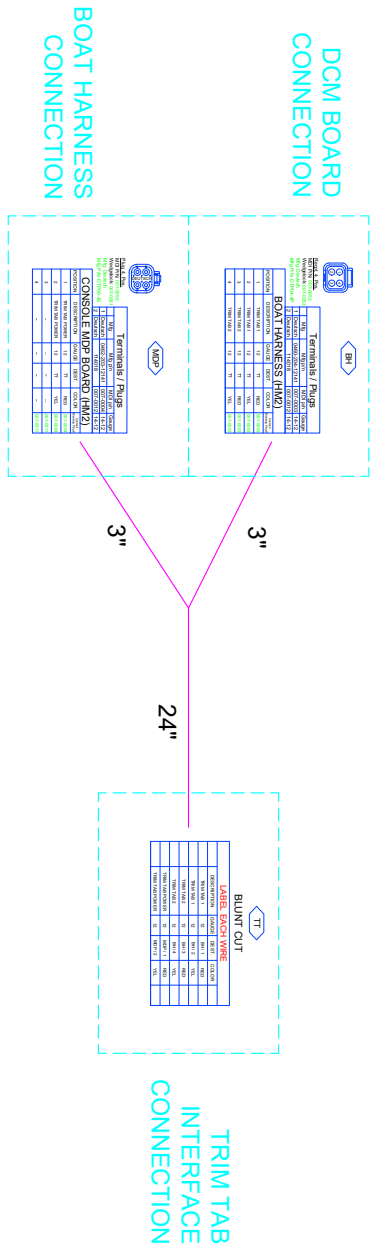

* * HARNESS CONTAINS NO SPLIT LOOM
* LABEL EACH CUSTOMER CONNECTION

2014 This document is solely the property of Dometic Marine/ Marine Digital Integrators, LLC. Any reproduction or distribution, either electronic or hard copy, of this document whether total or partial without the written consent of Marine Digital Integrators, LLC, is forbidden.

REVISION	DESCRIPTION	REV BY/DATE	CON	REV
1	INITIAL DESIGN	LIVYANA 10/20/13	MOLE	0
2				
3				
4				
5				

DESIGNED BY	J. WYNN	CHECKED BY	J. WYNN
APPROVED BY	C. DOUX		
7942 SW Ellison Way Shalaka, FL 32897 (727) 210-5200 FAX (727) 210-6207			
TITLE HARNESS, TRIM TAB INTERFACE		PART NUMBER 525-0018	SHEET B
DRAWN BY: J. WYNN	DATED: 10/20/13	SCALE: N/A	SHEETS: 1 of 1

Trim Tab Interface Harness



NOTES

DCM User Manual & Trouble Shooting Guide

↗ DOMETIC CONTROL SEASTAR DCM

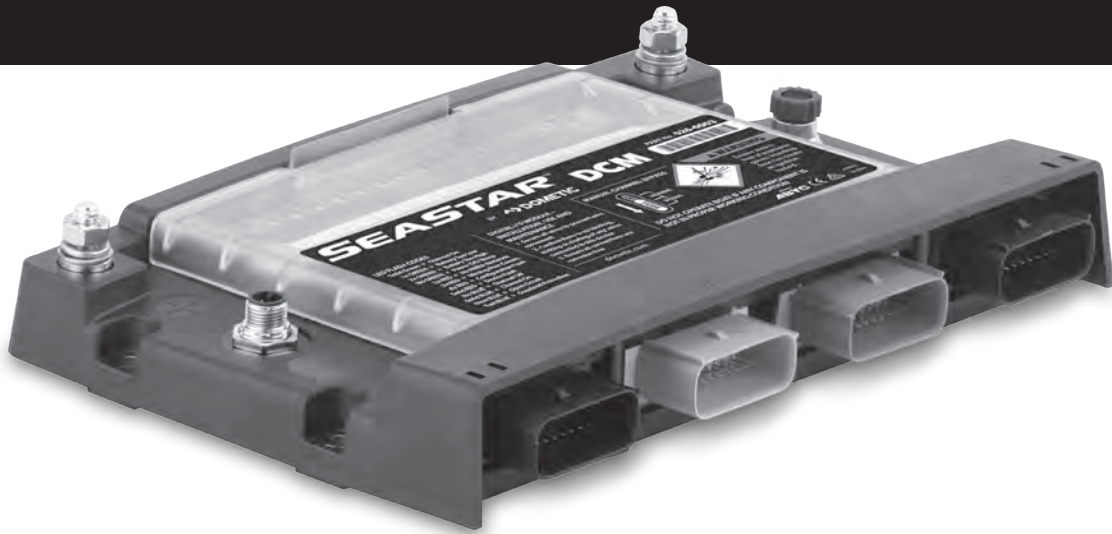

DCM Digital Switching 026-0003

EN **Product Description**
User Manual and Troubleshooting Guide

⚠ WARNING
Cancer and Reproductive Harm
www.P65Warnings.ca.gov



[REVISION A] Form No. 0000000.000 mm/19 | ©2019 Dometic Corporation
SeaStar

Service Center & Dealer Locations

Visit: www.dometic.com

Read these instructions carefully. These instructions **MUST** stay with this product.

Contents

1	Explanation of Symbols and Safety Instructions	2
1.1	Recognize Safety Information	2
1.2	Understand Signal Words	2
1.3	Safety Information	2
2	General Information	3
3	How The System Works	3
3.1	DCM Features	3
3.2	Wireless Key Fob for DCM Features	3
3.3	Layout	4
3.4	Key Fob Mounting Kit	4
3.5	Key Fob Pairing Procedure	4
3.6	Key Fob Battery Replacement	5
3.7	Switching Pages on MFD	5
3.8	Top/Bottom Ribbon Setup	6
3.9	Side Bar Setup	7
3.10	Change Switching Page Name	8
3.11	Replace Switches	8
3.12	Edit Switch Name	9
3.13	Warning Manager	10
3.14	Update DCM Configuration File	11
4	Troubleshooting Guide	13
4.1	DCM Troubleshooting	13
4.2	NMEA 2000 Network Troubleshooting	16
5	New Boat Checklist	17
6	Warranty Information	18
6.1	Statement of Limited Warranty	18
6.2	Return Goods Procedure	18
6.3	Technical Support	18

1 Explanation of Symbols and Safety Instructions

Thank you for choosing DCM Digital Switching Controller. This User Manual and Troubleshooting Guide contains all the information that you and others will require for the safe use of the DCM Digital Switching Controller and MUST remain on board the boat. Throughout this manual, information for the safe use of the controller will be distinguished in one of the following ways:

1.1 Recognize Safety Information

 **This is the safety alert symbol.** It is used to alert you to potential physical injury hazards. Obey all safety messages that follow this symbol to avoid possible injury or death.

1.2 Understand Signal Words

A signal word will identify safety messages and property damage messages, and also will indicate the degree or level of hazard seriousness.

 **WARNING**
Indicates a hazardous situation that, if **not** avoided, could result in death or serious injury.

 **CAUTION**
Indicates a hazardous situation that, if **not** avoided, could result in minor or moderate injury.

NOTICE: *Indicates an area or subject of special merit, emphasizing either the product's capabilities or common errors in operation or maintenance.*

1.3 Safety Information

The safety information provided below is intended to inform you of the dangers that may be present before, during and after the installation. It is critical that you read and understand ALL the points noted:

- Read and follow all safety information and instructions.
- Read and understand these instructions before [installing/ operating/ servicing] this product.

- The safe operation of the controller is dependent upon proper installation and maintenance, common sense, safe judgment and the knowledge/expertise of the operator. Every installer/user of the controller should know the following requirements 'before' installing/using the controller.
- If you have any questions regarding any of these warnings, contact Dometic.
- To reduce risk of severe injury or death. Always wear a Coast Guard Approved personal flotation device

2 General Information

The images used in this document are for reference purposes only. Components and component locations may vary according to specific product models.

3 How The System Works

Digital switching with the DCM greatly simplifies the electrical system on your boat. The system provides a cleaner dash by eliminating switches and placing them on the multi-function display. Through the display you can easily control your boat via single button touch. One touch operation modes on MFD combine different loads for smoother boat operation.

Custom modes and frequently used switches can be controlled via remote. The system can easily be turned on/off with the key fob.

3.1 DCM Features

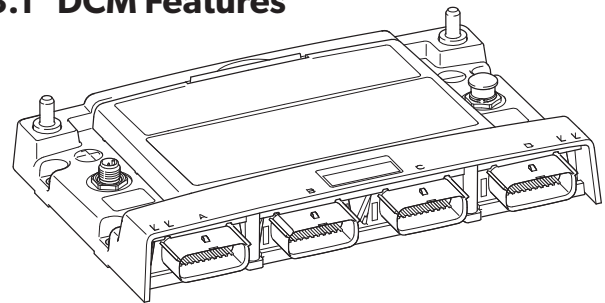

Figure 2.1. DCM

- Combined input and output channels in one module
- Touch screen compatible
- Small size and footprint
- 16x outputs channels
- 2x "always on" channels with removable fuses
- Load monitoring
- 6x analog inputs
- 16x switch inputs
- Fuse bypass available on all outputs
- Wireless remote control
- Battery management
- Voltage monitoring
- NMEA 2000 compatible
- Gateway to CAN devices

3.2 Wireless Key Fob for DCM Features

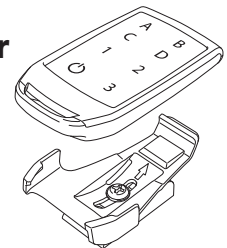
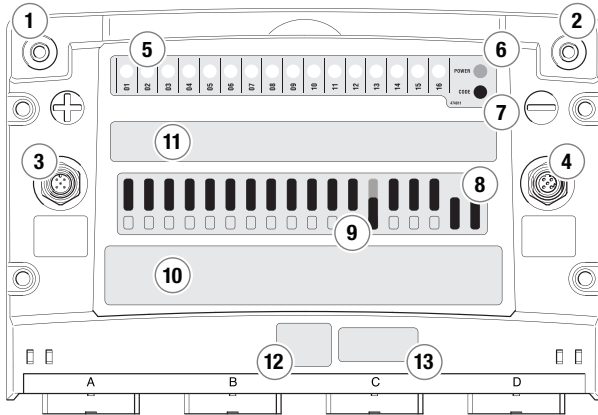

Figure 2.2. Generic key fob overlay shown. Actual overlay will look custom for your boat.

- Wirelessly connects with DCM
- Buttons pre-programmed in DCM for different operating modes.
- Multiple identical key fob's can be connected.
- Waterproof to a depth of 1 meter
- Optional dash mount holder
- 750-ft line of sight range
- 418 MHz, North America FCC certified
- Single 3V CR2032 Li cell
- Power button: Press and hold (1 sec. to turn on. 2 sec. to turn off)

3.3 Layout



Item	Name	Description
1	Positive Terminal	Connection to the house battery power.
2	Negative Terminal	Connection to the house battery ground.
3	NMEA 2000 Connector	Connection to NMEA 2000 network.
4	Ethernet Connector	Optional.
5	Channel Activity LED	LED ON shows when load is active.
6	Power LED	LED ON shows when DCM is powered.
7	Error Code LED	Error code list can be found in Section 3.1.
8	Always ON Channel Fuses	Fused output channels powered when DCM is powered.
9	Fuse Bypass	Use fuse bypass to turn the channel on in case of failure.
10	Input Channel Label	Channel inputs going to the DCM. This could be physical switches or analog sensor feedback.
11	Output Channel Label	Channel outputs and fuse values to loads controlled by DCM.
12	Serial Number Label	DCM serial number.
13	DCM Label	DCM info on: Boat model and model year / DCM part number and revision / Config part number and revision.

3.4 Key Fob Mounting Kit

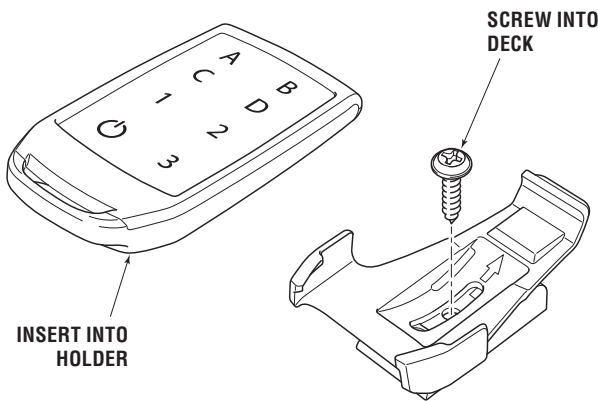

Figure 2-4. Key Fob Dash Mounting kit. NOTE: May already be installed on your boat.

3.5 Key Fob Pairing Procedure

In case your key fob lost pairing or you received a new key fob follow this procedure to pair the key fob to the DCM:

1. On the MFD Switching page find Remote Learn button.
2. Press and release the Remote Learn button on the MFD (the button is located on the MFD Switching page).
3. Press and release any button on the Key fob.
4. Wait 20 seconds for the DCM to exit programming mode.
5. The transmitter and DCM are now paired.
6. Repeat the pairing process for additional transmitters.
7. Up to 40 transmitter addresses can be stored in the DCM.

If a transmitter is lost or stolen, the user may want to clear it from the DCM's memory so that it can no longer control the DCM.

To erase all transmitter addresses, press and hold the Remote Learn button on the MFD for 15 seconds.

Note that all transmitters must then be re-paired with the DCM.

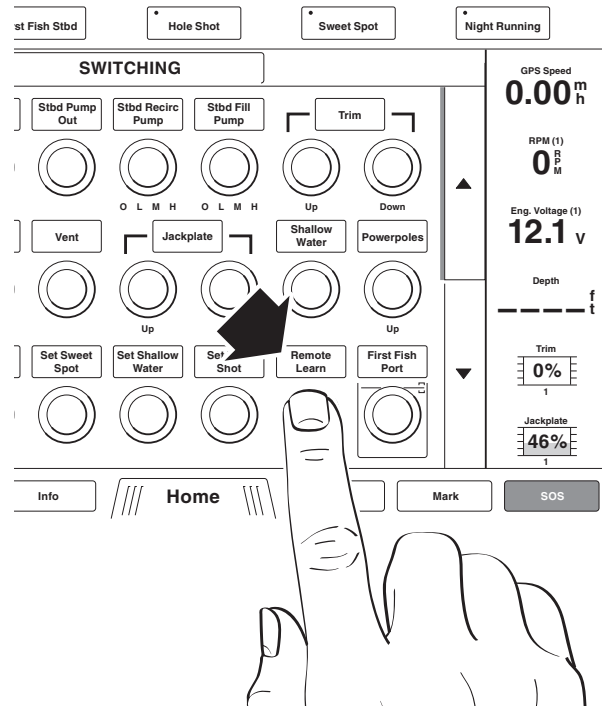

Figure 2-5.

3.6 Key Fob Battery Replacement

In order to replace the key fob battery, use the following procedure:

1. Remove the key fob from its cradle.
2. Using a small Phillips head screwdriver, remove the 4 small screws from the back of the key fob.
3. Gently pry open and remove the back cover and rubber seal.
4. Slide the battery out as shown in figure 2-6.
5. Inset a new CR2032 battery.
6. Reassembly is the reverse procedure, ensuring the rubber seal is located correctly in the grooves and is not pinched or twisted when locating the rear cover and securing screws.

NOTICE: The key fob utilizes a CR2032 battery. Do not substitute other.

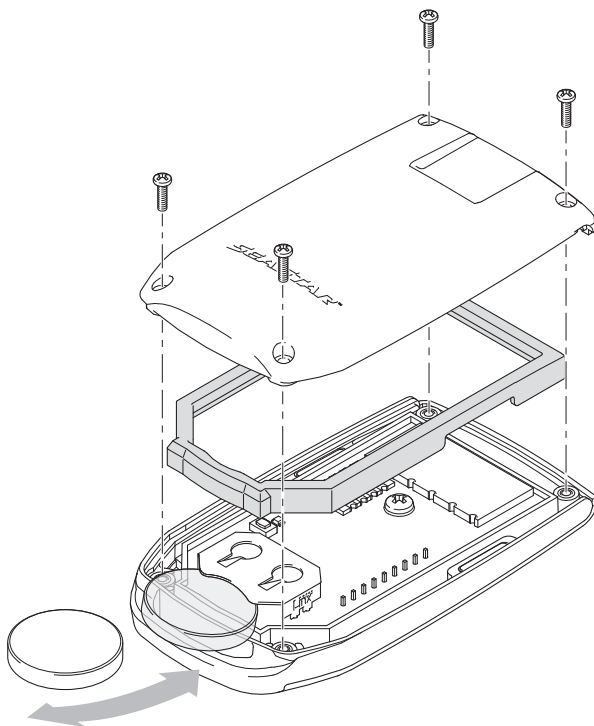

Figure 2-6. Key fob battery replacement.

3.7 Switching Pages On MFD

To access Devices controlled by the DCM on the MFD, navigate to the Switching page, through Home > OneHelm, A/V, Gauges. You will find all the devices controlled by the DCM there. In addition, some of these loads might have already been combined into Modes as predefined by your boat model. On GPS Map you can find these modes on the Switching page as indicated by the blue button. ECHOMap Modes have unique buttons with a centre symbol. They can be loaded into the Modes ribbon for easy access when on other pages on your MFD.

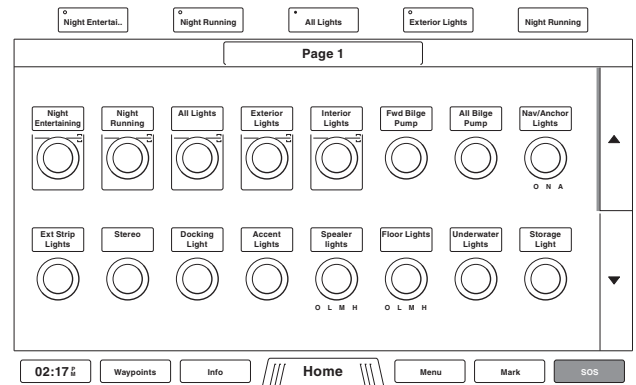

Figure 2-7. NOTE: Button layout and labels may look different on your boat.

DIFFERENT MODES ON TOP RIBBON FOR QUICK ACCESS

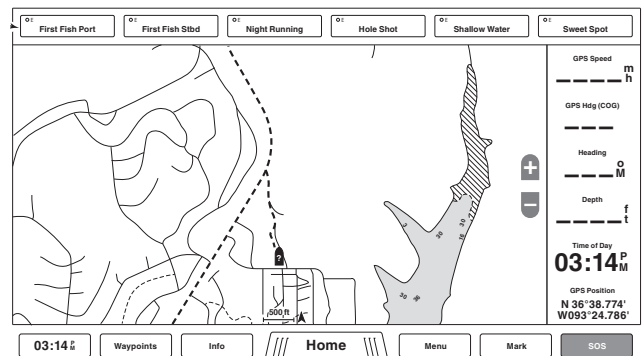

Figure 2-8. NOTE: Button layout and labels may look different on your boat.

3.8 Top/Bottom Ribbon Setup

NOTICE: Follow this same procedure for any other page you want top/bottom ribbon added.

1. Go to Switching page and select Menu.

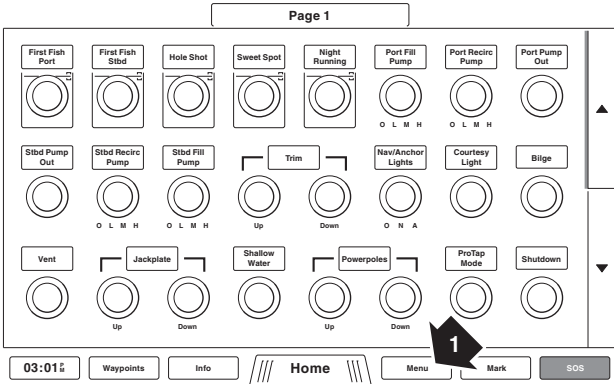

Figure 2-9. NOTE: Button layout and labels may look different on your boat.

2. Select Edit Overlays

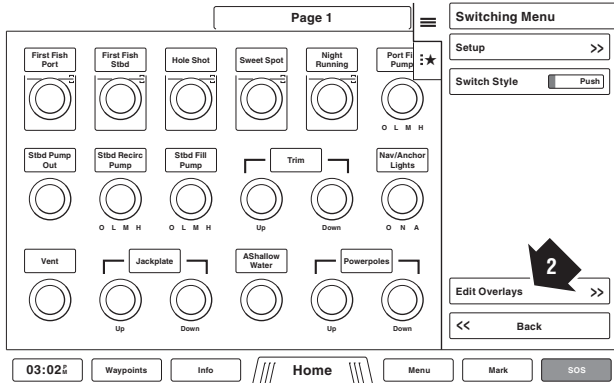
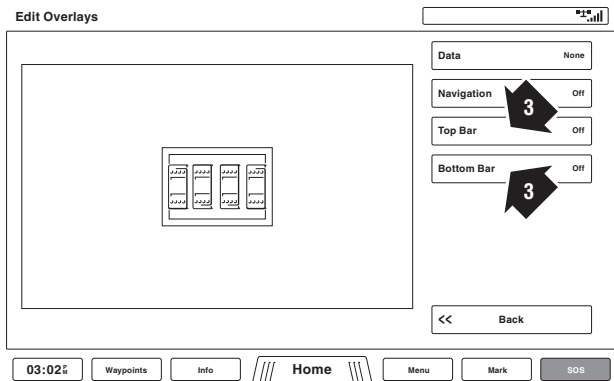

Figure 2-10. NOTE: Button layout and labels may look different on your boat.

3. Select Top Bar or Bottom Bar



6 Figure 2-11

4. Select Circuit Control

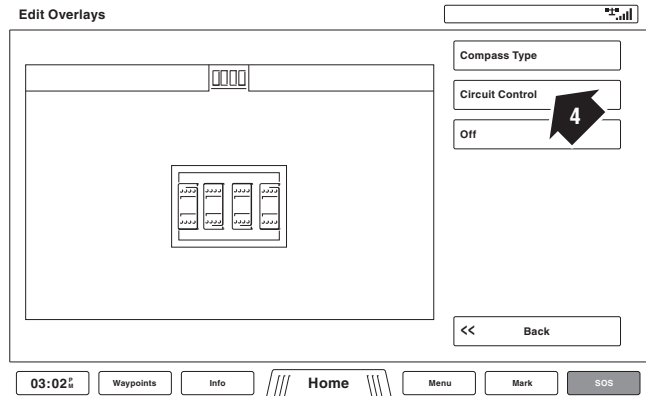

Figure 2-12

5. Quit the menu and enjoy your modes ribbon.

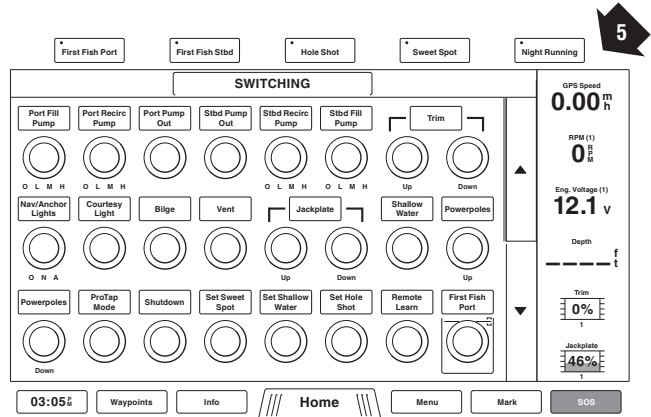

Figure 2-13. NOTE: Button layout and labels may look different on your boat.

3.9 Side Bar Setup

NOTICE: Follow this same procedure for any other page you want a side bar added to.

1. Go to Switching page and select Menu.

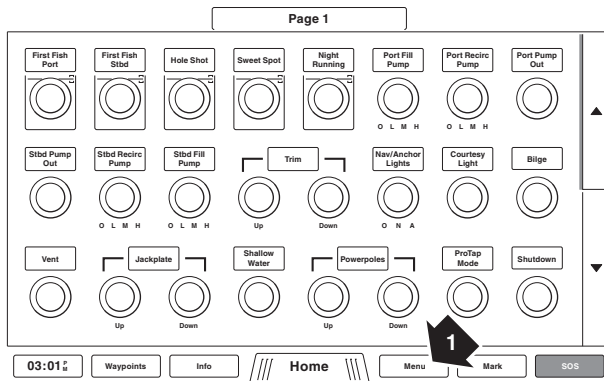

Figure 2-14. NOTE: Button layout and labels may look different on your boat.

2. Select Edit Overlays

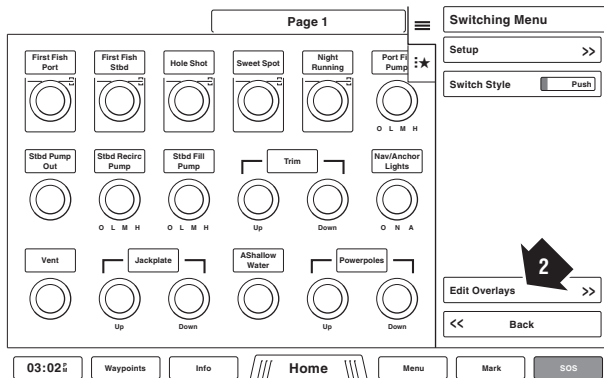
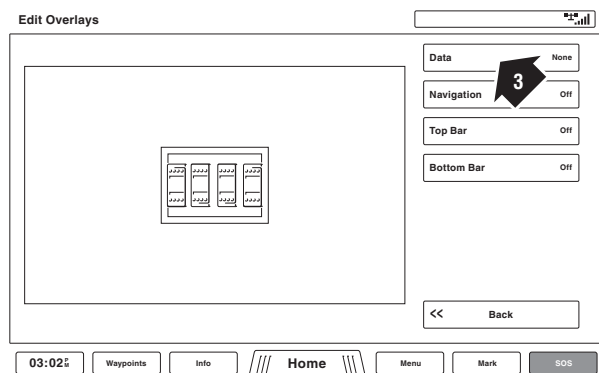

Figure 2-15. NOTE: Button layout and labels may look different on your boat.

3. Select Data



EN Figure 2-16

4. Select Side Bar, then select the data you would like shown

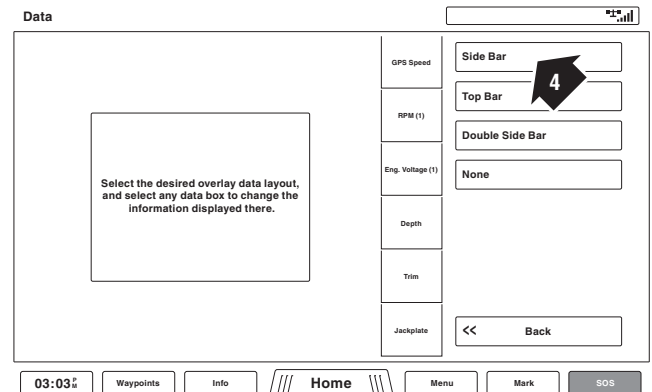

Figure 2-17

3.10 Change Switching Page Name

1. From Switching menu select Menu
2. Select Setup
3. Select Edit Page.

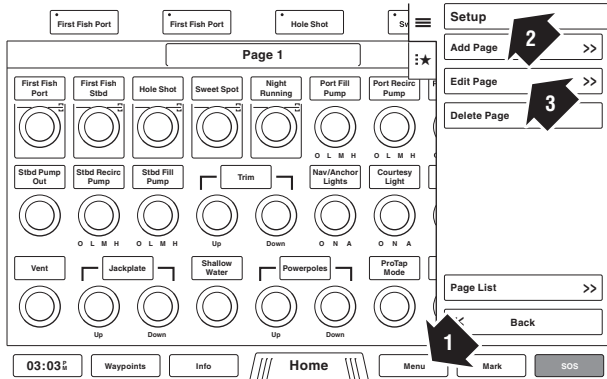

Figure 2-18. NOTE: Button layout and labels may look different on your boat.

4. Select Name

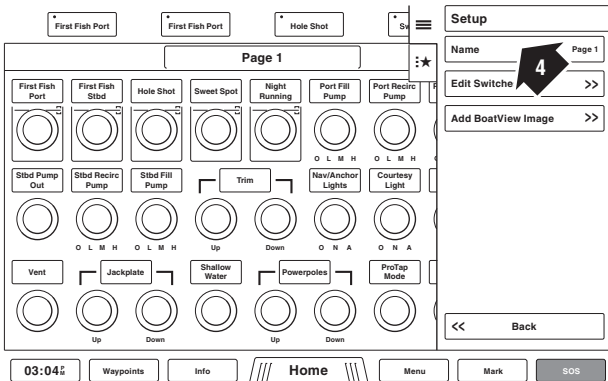
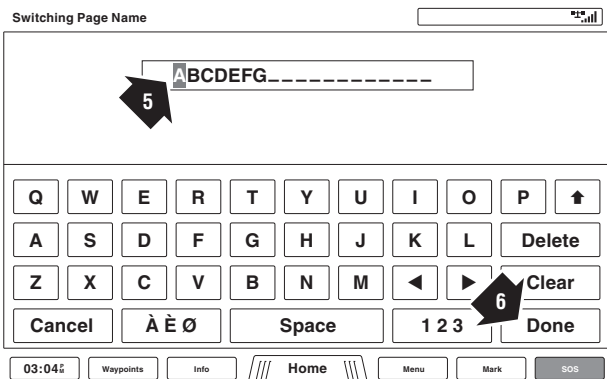

Figure 2-19. NOTE: Button layout and labels may look different on your boat.

5. Enter Desired Page Name

6. Select Done When Finished



8 Figure 2-20

3.11 Replace Switches

1. Select Edit Switches

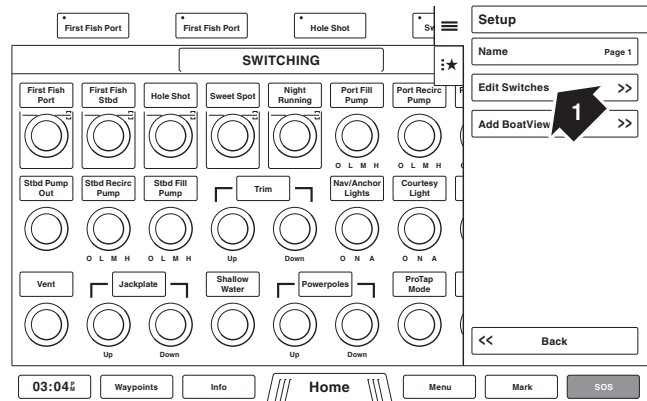

Figure 2-21. NOTE: Button layout and labels may look different on your boat.

2. Select Replace All Switches

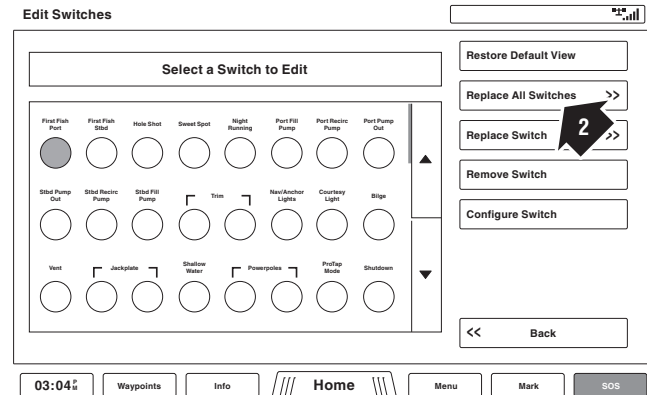

Figure 2-22. NOTE: Button layout and labels may look different on your boat.

3. Select the Mode Switches You Want Removed

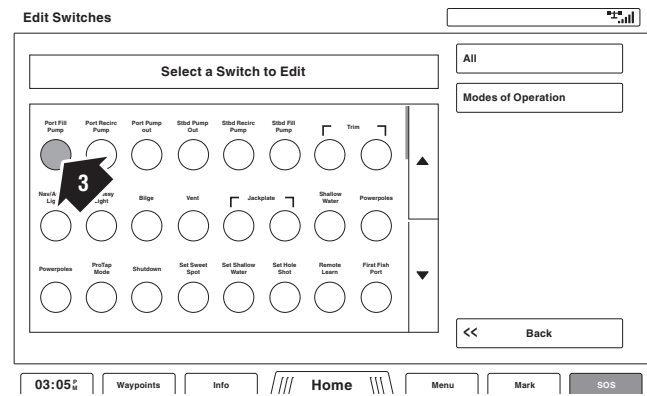

Figure 2-23. NOTE: Button layout and labels may look different on your boat.

4. Quit the menu altogether and enjoy your Switching screen

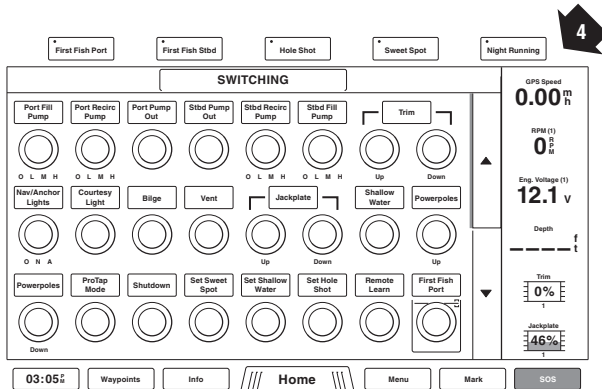

Figure 2-24. NOTE: Button layout and labels may look different on your boat.

3. Select Edit Page

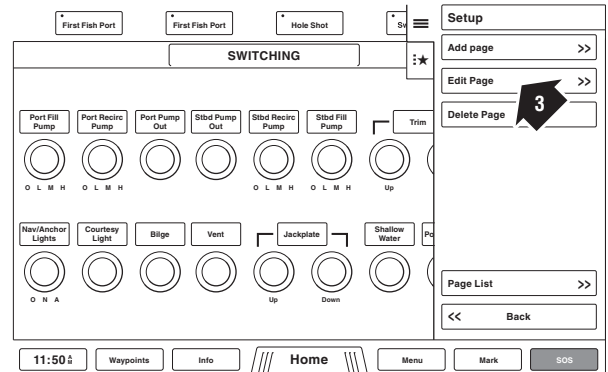

Figure 2-26. NOTE: Button layout and labels may look different on your boat.

3.12 Edit Switch Name

NOTICE: This function is ONLY available with DCM software Rev. G or later.

1. Go to Switching page and Select Menu.
2. Select Setup

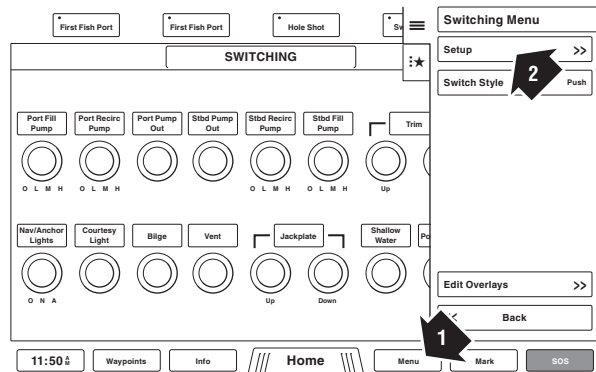

Figure 2-25. NOTE: Button layout and labels may look different on your boat.

4. Select Edit Switches

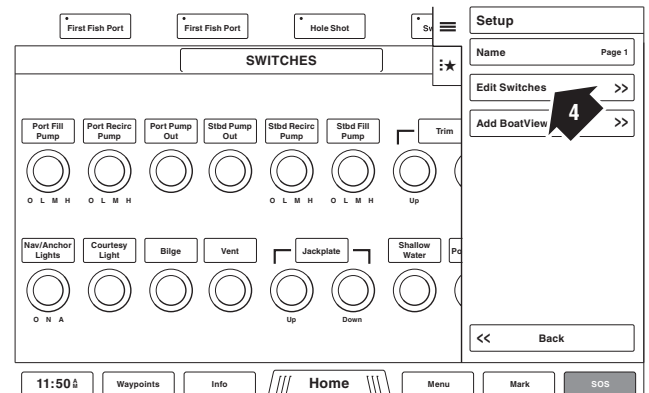

Figure 2-27. NOTE: Button layout and labels may look different on your boat.

4. Select the switch you want to rename
6. Select Configure Switch

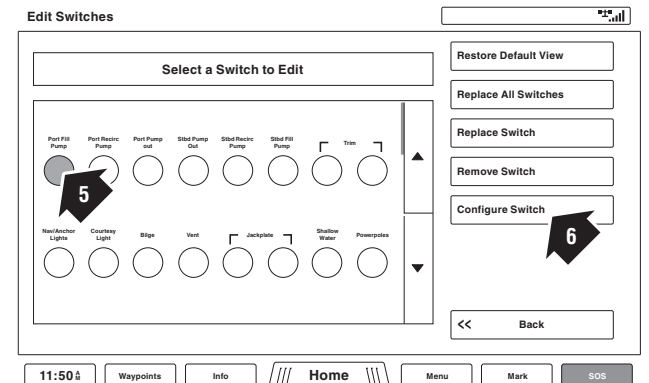

Figure 2-28. NOTE: Button layout and labels may look different on your boat.

7. Select Edit Name

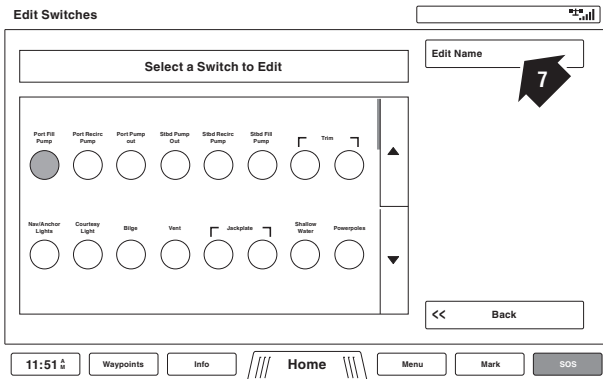

Figure 2-29. NOTE: Button layout and labels may look different on your boat.

8. Enter the desired switch name

9. Select Done when finished

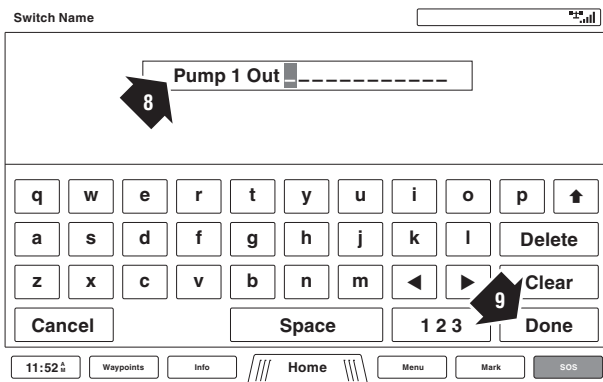
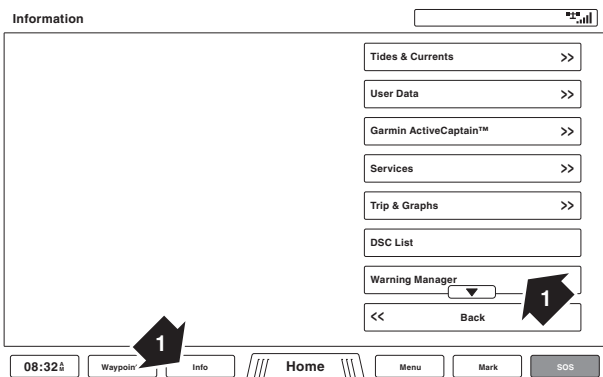

Figure 2-30.

3.13 Warning Manager

1. Select Info from the bottom menu and then select Warning Manager



10 Figure 2-31

2. On the next page you will see the list of faults.

DCM faults will be labeled SeaStar by Dometic 026-0003: DCM - 0

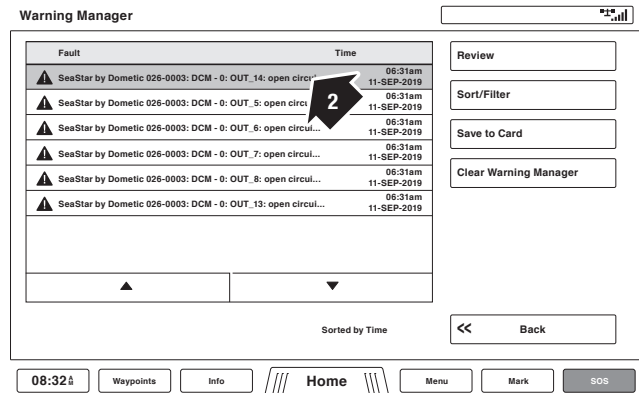

Figure 2-32. *

NOTE: Older models may show "SeaStar Solutions 026-0003: DCM - 0:"

3. Select a fault you would like to review for additional info

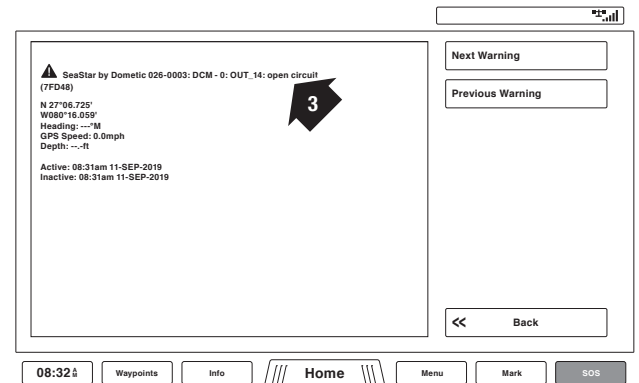
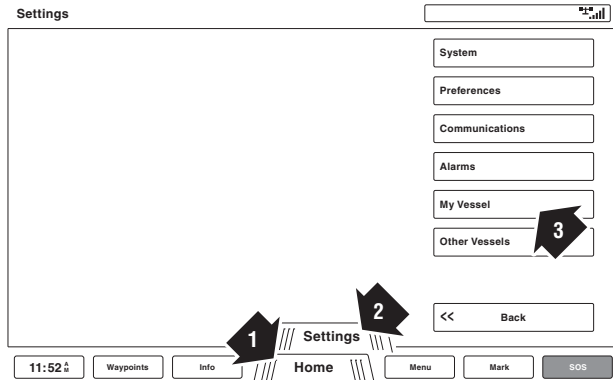

Figure 2-33.

NOTE: Older models may show "SeaStar Solutions 026-0003: DCM - 0:"

3.14 Update DCM Configuration File

1. From any screen select Home. Home button will become Settings button.
2. Select Settings
3. Select My Vessel



4. Select SeaStar

Figure 2-34.

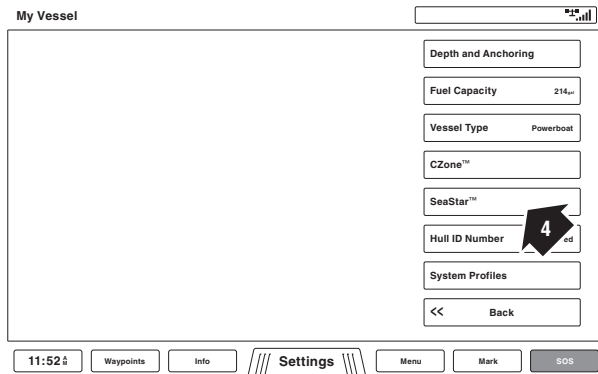

Figure 2-35.

5. Select SeaStar Config. File

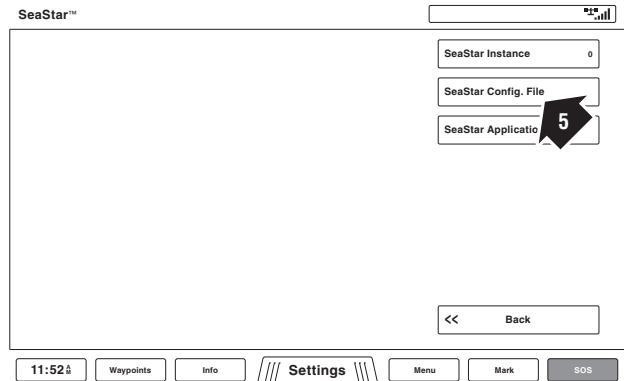

Figure 2-36.

6. Select Load From Card

7. Select the DCM you want to update

8. Select Select Device

- a. In a multi DCM system, locate the DCM you want to update and note its serial number on its label to identify it within the list
- b. On the Serial # column you should see the DCM serial number

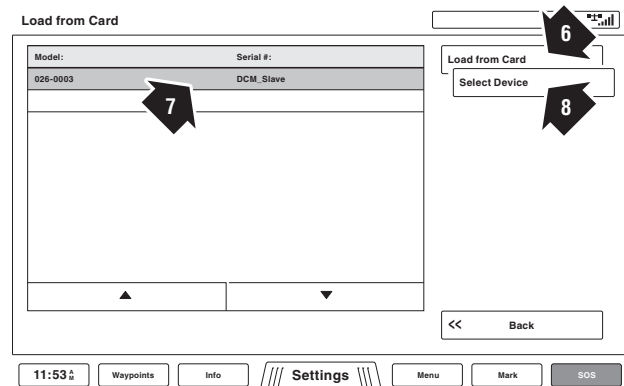

Figure 2-37.

9. Select the configuration file you want to update, then select Load From Card

NOTICE: The config part number and revision are listed on DCM Label (item 13, Section 3.3).

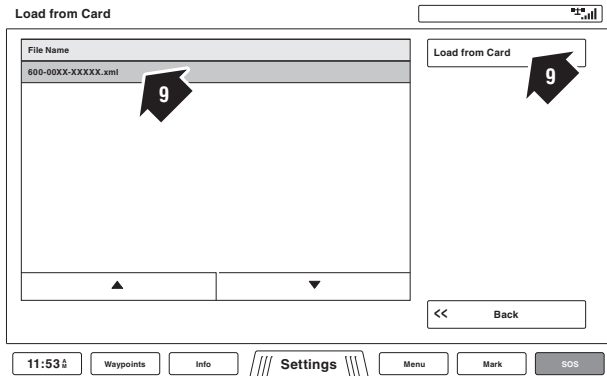

Figure 2-38

10. Select Yes

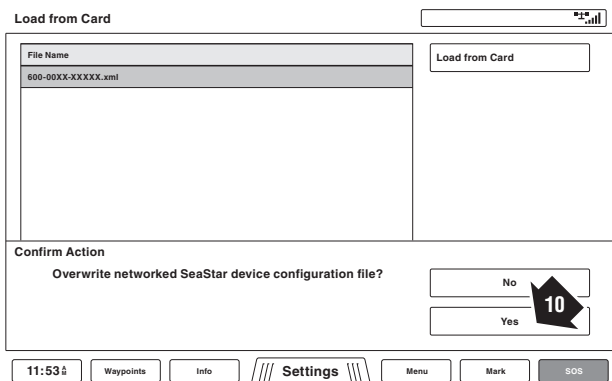

Figure 2-39

11. Wait for the Transfer

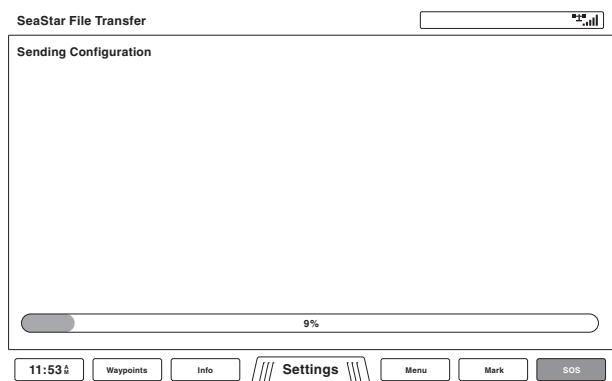

Figure 2-40

12. Leave settings

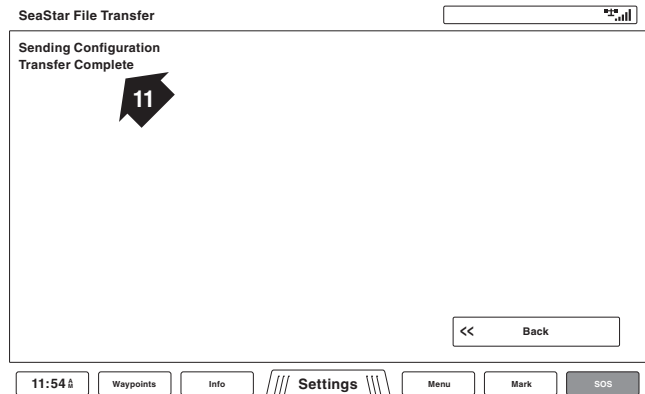

Figure 2-41

4 Troubleshooting Guide

4.1 DCM Troubleshooting

LED Flash Codes		
Solid GREEN = Channel On	2 x RED = No NMEA Network	No BLUE = Channel Off
1 x GREEN = Battery Too Low	3 x RED = Missing Peer Comm.	Solid BLUE = Channel On
2 x GREEN = Battery Too High	4 x RED = Configuration Fault	Slow BLUE = Open Circuit
No GREEN = Power Off/Sleep	Solid RED = Device Fault	Fast BLUE = Overload Protection

DCM		
Symptoms	Potential Causes	Checking Steps and Solutions
Power LED off	<ul style="list-style-type: none"> a) House battery switch off b) Module off c) Module failure 	<ul style="list-style-type: none"> a) Check house battery switch to be ON position. Measure voltage across module power + and - to be above 9 VDC. Ensure all battery positive and negative wires secured. b) Reset house battery switch to off and on to wake up unit. c) Call OEM or SeaStar service for assistance.
Power LED green flash 1x pulse	<ul style="list-style-type: none"> a) Dead battery b) Charging source disconnected 	<ul style="list-style-type: none"> a) Measure voltage across module power + and - to be above 9 VDC. Ensure all battery positive and negative wires are secured. b) Check voltage when charging engine is running. Ensure VSS or VSR is active.
Power LED green flash 2x pulses	<ul style="list-style-type: none"> a) Overvoltage 	<ul style="list-style-type: none"> a) Measure voltage across module power + and - to be between 9 and 16 VDC. Trace battery positive and negative wire to a single battery.
Status LED red flash 2x pulses (missing NMEA network)	<ul style="list-style-type: none"> a) MFD power off b) NMEA network missing terminating resistors c) Faulty NMEA network 	<ul style="list-style-type: none"> a) Ensure MFD can be turned on. Check power supply and fuse to MFD. b) Verify NMEA backbone has 2 terminating resistors. c) Refer to section 3.2 "NMEA 2000 Network Troubleshooting".
Status LED red flash 3x pulses (missing MFD)	<ul style="list-style-type: none"> a) Missing compatible MFD b) Improper DCM setup 	<ul style="list-style-type: none"> a) Check home page of MFD to ensure Switching Icon exist. Update MFD software to the latest from MFD manufacturer. Check Home/Setting/Communication/Device List for SeaStar DCM.
Device load does not turn on when pressed at MFD	<ul style="list-style-type: none"> a) Load's associated fuse is blown b) Load wiring or load itself has a problem 	Remove cover on module. Use output channel label to locate fuse for the load: <ul style="list-style-type: none"> a) Check the fuse. b) Move the fuse to the manual bypass position to check if the load will turn on.
A device load does not turn on even though associated load status indicator shows blue(ON)	<ul style="list-style-type: none"> a) Load's associated fuse is blown b) Load wiring or load itself has a problem 	Remove cover on module. Use output channel label to locate fuse for the load: <ul style="list-style-type: none"> a) Check the fuse. b) Move the fuse to the manual bypass position to check if the load will turn on.
A device load turning outputs ON without being commanded	<ul style="list-style-type: none"> a) Load fuse at the bypass position 	Remove cover on module. Use output channel label to locate fuse for the load: <ul style="list-style-type: none"> a) Move the fuse back to the normal position.
Signal input erratic for Meter or Switch Input	<ul style="list-style-type: none"> a) Missing ground signal b) Incorrect/multiple ground signals 	<ul style="list-style-type: none"> a) Verify DCM has a ground signal at main ground lug. b) Verify DCM shares the same source ground as the signal being measured.
A switch connected to DCM that previously worked does not operate	<ul style="list-style-type: none"> a) Switch is faulty b) Switch wiring is faulty 	<ul style="list-style-type: none"> a) Meter/test switch continuity. Replace switch with known working switch. b) Verify secure and proper connections to DCM. Meter/test switch continuity.

Garmin Screen MFD (Multi-Function Display)		
Symptoms	Potential Causes	Checking Steps and Solutions
When accessing a "switching" page on Garmin MFD there appears to be missing switches or voids where switches should be	a) Garmin "switching" page must be reset	a) From the problematic Garmin screen "switching" page press: Menu > Edit switches > Replace all switches, then select which switch group you desire for the particular page.
When pressing a switch on Garmin MFD the load stays on but a momentary operation is desired	a) The switch defined by the OEM as toggle ON/OFF, not momentary	a) Provide feedback to dealer and OEM.
Gauges for fuel/ water or waste tank data erratic	a) Sensor wiring	a) After verifying gauge data is supposed to come from DCM device, check wiring at tank sensor and DCM.
When trying to load a new configuration using Garmin card reader with SD card the system shuts down	a) Garmin MFD is powered from the DCM and is powering off when receiving prompt to load a new configuration	a) Place DCM output fuse for MFD into "Bypass Mode" to give continuous power to MFD during update. It is recommended that a correction to the DCM configuration is made using SeaStar DCM configuration tool so the particular output does not power off during future configuration uploads. Call OEM or SeaStar Service for assistance as needed.
On Garmin MFD Switching page, turning on a switch, two circuit indicators turn on when only one should	a) DCM configuration needs to be updated to correct the issue	a) Correct DCM configuration using SeaStar DCM configuration tool. Call OEM or SeaStar Service for assistance as needed.
Garmin screen shows message "Out of Range" (Example: Out of Range: Freshwater)	a) The sender/full system may not be energized b) DCM module is not connected to the NMEA 2000 network c) The sender is not properly connected to DCM module	a) Check the sender's breaker is in the "ON" Position. b) Find associated DCM module and check device for loose NMEA 2000 connection. c) Check for sender data at DCM module using a multi-meter.
Garmin screen shows "Unavailable" message instead of switches when on "switching" page	a) Garmin MFD not connected to NMEA 2000 network b) SeaStar Instance not set on MFD c) Switching page needs to be reset	a) From the Garmin screen homepage press: Settings/ Communication/ NMEA 2000 set-up/ Device List... Does the device list show other devices on the NMEA network? If not, replace Garmin unit's NMEA drop cable. If problem persists refer to section 3.2 "NMEA 2000 Network Troubleshooting". b) From the Garmin screen homepage press: Settings > My Vessel > Switching > SeaStar > SeaStar Instance to be '0' c) From the switching page press: Menu > Edit Switches > Restore Default View
In multi MFD installation, switching buttons functional only on one MFD	MFD instancing does not match DCM config file	Call SeaStar Service for assistance.
Fuel/Water/Waste tank data not present on MFD	a) Tank sender not connected to DCM module b) Tank sender type NMEA instance incorrect on MFD	a) Follow tank sender wiring to verify secure connection to designated DCM module position. Measure voltage at the sender connection. b) From the Garmin Gauges page press: Menu > Edit Gauges Page > Replace Data.

Power Management/ Battery Switches & Key Fob		
Symptoms	Potential Causes	Checking Steps and Solutions
Load breaker tripped or blown fuse	<ul style="list-style-type: none"> a) Improper voltage caused load current to rise causing breaker to trip or fuse to blow b) Harness has short circuit c) Load/device has short circuit d) If tripped repeatedly weak/faulty breaker 	<ul style="list-style-type: none"> a) Measure system voltage and restore by charging battery if required. b) Disconnect load and turn on breaker or replace fuse to see if the breaker trips or fuse blows, if it does, there is a short circuit within the breaker's associated wiring harness. c) Disconnect the load from DCM, the breaker or the fuse. Measure resistance on the load to check for short circuit. Test/ replace with a working load device. d) Check breaker's load value with a DC current meter (Amp Clamp), If the load is pulling less than the breaker's capable current rating, replace the breaker.
Wireless key fob doesn't work	<ul style="list-style-type: none"> a) Battery inside key fob requires replacement b) Key fob needs to be paired with DCM c) Faulty Key fob or receiver 	<ul style="list-style-type: none"> a) Replace battery. b) See section See 2.7 "Key Fob Pairing Procedure." c) Test/replace with a working receiver.
Audible noise from speaker system when load device is active	<ul style="list-style-type: none"> a) The load device is grounded in between the Stereo head unit and stereo amplifier b) The load device is grounded in between the battery and the stereo amplifier c) A DCM load is creating PWM (Pulse With Modulation) noise that is bleeding into speaker wires 	<ul style="list-style-type: none"> a) Install a new (separate) 14 AWG ground wire directly from stereo head unit ground to stereo amplifier ground. b) Ensure stereo amplifier ground is terminated as close to the battery as possible with no load grounds in between. Or, apply solution (a). c) Re-route speaker wires away from DCM load wires.

4.2 NMEA 2000 Network Troubleshooting

- Usually troubleshooting requires nothing more than a few basic tools and knowledge of what a proper NMEA 2000 backbone construction should consist of. Given the tools and knowledge, troubleshooting could be considered easy, as all the parts are "Plug and play." Usually technicians use the process of elimination to find and eliminate problems. This method is recommended at times however, may not always work swiftly if there is more than one piece of faulty equipment on the network.
- It is recommended to take a NMEA cable and cut the female end off of the cable, strip back the conductors from the remaining male cable and terminate them onto a terminal strip as shown in figure 3-1. This simple tool will plug into any open position on the network allowing for easy ability to meter different parts of the network.
- If there is a problem with a NMEA 2000 network, it is recommended to start by removing network devices one at a time. If the network works properly immediately after removing a device, it is safe to assume there may be a problem with the device or the associated network drop cable. If this method does not resolve the network problems the next step would be to test the network by metering.

When Metering a NMEA 2000 network

The resistance between Net-H (White) and Net-L (Blue) should be approx. 60 Ohms with the network power turned off.

If this parameter is not met:

- Verify proper construction of NMEA network while checking for loose connections
- Replace terminating resistors
- If value is still incorrect: Remove all devices from network, check value again, determine faulty network "T"s, cables or network power isolators by using process of elimination. Replace necessary items effecting the network backbone.

With network power on the network voltage (Red & Black) should not be below 11V or Above 15V If this parameter is not met:

- Charge system batteries
- Check charging system for proper voltage output
- Verify proper construction of NMEA network while checking for loose connections
- Replace power insertion "T"

- If value is still incorrect: Remove all devices from network, check value again, determine faulty network "T"s, cables or network power isolators by using process of elimination.

Replace necessary items effecting the network backbone.

The shield and DC (-) conductor should have continuity

Although it is possible NMEA networks can be effected by interference it is unlikely.

This rule exists for purposes to shield the network from interference.

If this parameter is not met:

- Check power insertion point for proper connection, where the shield is connected to DC (-).

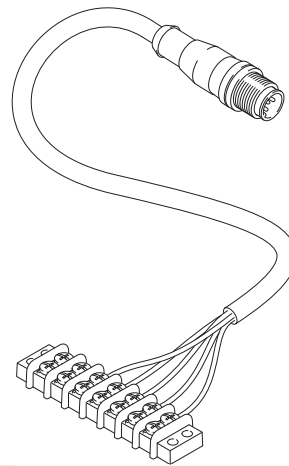

Figure 4.1

5 New Boat Checklist

New Boat Customer Orientation

Notes

Action	Dealer Initial
Power ON/OFF battery switch location and function (off for extended storage)	
Turn power ON/OFF using key fob	
Explain battery switch ON/OFF cycle, if key fob not available	
Explain all key fob functions	
Navigate to switching page on Garmin MFD	
Go through each switch and describe how it works	
Show settings page on Garmin MFD	
Show favorites combo page	
Download and set-up Garmin ActiveCaptain™ and show operation	
Show how to change modes and switching page name	
Show how to change switch type	
Show how to edit overlays with top bar, circuit control	
Show location of MDP panel and DCM	
Show how to bypass channels using DCM fuses	
Show DCM lid with flash code explanations	



6 Warranty

6.1 Statement of Limited Warranty

The DCM system is factory installed by the original boat manufacturer. Please go through the boat dealer to contact the boat builder.

We warrant to the original retail purchaser that Marine Canada Acquisition Inc. DBA DOMETIC VANCOUVER (herein forward referred to as Dometic) products have been manufactured free from defects in materials and workmanship. This warranty is effective for two years from date of purchase, excepting that where Dometic products are used commercially or in any rental or income producing activity, then this warranty is limited to one year from the date of purchase.

We will provide replacement product without charge, for any Dometic product meeting this warranty, which is returned (freight prepaid) within the warranty period to the dealer from whom such product were purchased, or to us at the appropriate address. In such a case Dometic products found to be defective and covered by this warranty, will be replaced at Dometic's option, and returned to the customer.

The above quoted statement is an extract from the complete Dometic products warranty statement. A complete warranty policy is available in our Dometic products catalogue.

For more information please visit our website:
www.dometic.com

6.2 Return Good Procedure

Prior to returning the product to Dometic please call:
772-210-2403

6.3 Technical Support

Phone: 772-210-2403

email: seastar@dometic.com

Hours: Monday to Friday 05:00 – 15:30 PST



Mobile living made easy.

**YOUR LOCAL
DEALER**

dometic.com/dealer

**YOUR LOCAL
SUPPORT**

dometic.com/contact

**YOUR LOCAL
SALES OFFICE**

dometic.com/sales-offices

A complete list of Dometic companies, which comprise the Dometic Group, can be found in the public filings of:
DOMETIC GROUP AB Hemvärnsgatan 15 SE-17154 Solna Sweden



DOMETIC STUART
7667 SW Ellipse Way,
34997 Stuart, FL
United States

www.dometic.com

ISO 10592
CE

form no. 604-0000 REV. B



© 2019 Dometic MARINE AMERICAS
PRINTED IN USA 12/19

Please scan
this QR code
and watch our
latest Boating
Safety video.



DEPARTMENT OF TRANSPORTATION U.S. COAST GUARD CG-3865 (Rev. 9/95)		BOATING ACCIDENT REPORT		FORM APPROVED OMB NO. 2115-0010			
STATE ASSIGNED CASE NO. _____							
<p>THE OPERATOR/OWNER OF A VESSEL USED FOR RECREATIONAL PURPOSES IS REQUIRED TO FILE A REPORT IN WRITING WHENEVER AN ACCIDENT RESULTS IN: LOSS OF LIFE OR DISAPPEARANCE FROM A VESSEL; AN INJURY WHICH REQUIRES MEDICAL TREATMENT BEYOND FIRST AID; OR PROPERTY DAMAGE IN EXCESS OF \$2000 OR COMPLETE LOSS OF THE VESSEL. REPORTS IN DEATH AND INJURY CASES MUST BE SUBMITTED WITHIN 48 HOURS. REPORTS IN OTHER CASES MUST BE SUBMITTED WITHIN 10 DAYS. REPORTS MUST BE SUBMITTED TO THE REPORTING AUTHORITY IN THE STATE WHERE THE ACCIDENT OCCURRED. THIS FORM IS PROVIDED TO ASSIST THE OPERATOR IN FILING THE REQUIRED WRITTEN REPORT.</p>							
COMPLETE ALL BLOCKS (INDICATE THOSE NOT APPLICABLE BY "NA")							
ACCIDENT DATA							
DATE OF ACCIDENT	TIME AM PM	NAME OF BODY OF WATER		LOCATION (GIVE LOCATION PRECISELY)			
NUMBER OF VESSELS INVOLVED	NEAREST CITY OR TOWN		COUNTY	STATE	ZIP CODE		
WEATHER (CHECK ALL APPLICABLE) [] CLEAR [] RAIN [] CLOUDY [] SNOW [] FOG [] HAZY	WATER CONDITIONS [] CALM (WAVES LESS THAN 6") [] CHOPPY (WAVES 6" TO 2') [] ROUGH (WAVES 2' TO 6') [] VERY ROUGH (GREATER THAN 6') [] STRONG CURRENT	TEMPERATURE (ESTIMATE) AIR _____ °F WATER _____ °F	WIND [] NONE [] LIGHT (0-6 MPH) [] MODERATE (7-14 MPH) [] STRONG (15-25 MPH) [] STORM (OVER 25 MPH)	VISIBILITY DAY NIGHT [] GOOD [] [] FAIR [] [] POOR []			
NAME OF OPERATOR			OPERATOR ADDRESS				
OPERATOR TELEPHONE NUMBER ()	DATE OF BIRTH MO DAY YR	OPERATOR'S EXPERIENCE [] NONE [] UNDER 100 HOURS [] > 100 HOURS	INSTRUCTION IN BOATING SAFETY [] STATE COURSE [] U.S. POWER SQUADRON [] USCG AUXILIARY [] AMERICAN RED CROSS [] NONE				
[] MALE [] FEMALE							
NAME OF OWNER			OWNER ADDRESS				
OWNER TELEPHONE NUMBER ()	NUMBER OF PEOPLE ON BOARD	NUMBER OF PEOPLE BEING TOWED	RENTED BOAT? [] YES [] NO				
BOAT NO. 1 (THIS VESSEL)							
BOAT REGISTRATION OR DOCUMENTATION NUMBER		STATE	HULL IDENTIFICATION NUMBER	BOAT NAME			
BOAT MANUFACTURER		LENGTH	MODEL	YEAR BUILT			
TYPE OF BOAT [] OPEN MOTORBOAT [] CABIN MOTORBOAT [] AUXILIARY SAIL [] SAIL (ONLY) [] ROWBOAT [] CANOE/KAYAK [] PERSONAL WATERCRAFT [] PONTOON BOAT [] HOUSEBOAT [] OTHER (SPECIFY)	HULL MATERIAL [] WOOD [] ALUMINUM [] STEEL [] FIBERGLASS [] RUBBER/VINYL/CANVAS [] RIGID HULL INFLATABLE [] OTHER (SPECIFY)	ENGINE [] OUTBOARD [] INBOARD [] INBOARD-STERNDRIVE (I/O) [] AIRBOAT	PROPULSION [] PROPELLER [] WATER JET [] AIR THRUST [] MANUAL [] SAIL	PERSONAL FLOTATION DEVICES (PFDS): WAS BOAT ADEQUATELY EQUIPPED WITH COAST GUARD APPROVED PFDS? [] YES [] NO WERE PFDS ACCESSIBLE? [] YES [] NO			
		FUEL [] GASOLINE [] DIESEL [] ELECTRIC	NUMBER OF ENGINES TOTAL HORSEPOWER	FIRE EXTINGUISHERS ON BOARD? [] YES [] NO USED? [] YES [] NO			
OPERATION AT TIME OF ACCIDENT (CHECK ALL APPLICABLE) [] CRUISING [] CHANGING DIRECTION [] CHANGING SPEED [] DRIFTING [] TOWING [] BEING TOWED [] ROWING/PADDLING [] SAILING [] LAUNCHING [] DOCKING/UNDocking [] AT ANCHOR [] TIED TO DOCK/MOORED [] OTHER (SPECIFY)		ACTIVITY AT TIME OF ACCIDENT (CHECK ANY IF APPLICABLE) [] FISHING [] TOURNAMENT [] HUNTING [] SWIMMING/DIVING [] MAKING REPAIRS [] WATERSKIING/TUBING/ETC. [] RACING [] WHITEWATER SPORTS [] FUELING [] STARTING ENGINE [] NON-RECREATIONAL [] OTHER (SPECIFY)	TYPE OF ACCIDENT [] GROUNDING [] CAPSIZING [] FLOODING/SWAMPING [] SINKING [] FIRE OR EXPLOSION (FUEL) [] FIRE OR EXPLOSION (OTHER) [] SKIER MISHAP [] COLLISION WITH VESSEL [] COLLISION WITH FIXED OBJECT [] COLLISION WITH FLOATING OBJ. [] FALLS OVERBOARD [] FALLS IN BOAT [] STRUCK BY BOAT [] STRUCK BY MOTOR/PROPELLER [] STRUCK SUBMERGED OBJECT [] OTHER (SPECIFY)			WHAT CONTRIBUTED TO ACCIDENT? (CHECK ALL APPLICABLE) [] WEATHER [] EXCESSIVE SPEED [] IMPROPER LOOKOUT [] RESTRICTED VISION [] OVERLOADING [] IMPROPER LOADING [] HAZARDOUS WATERS [] ALCOHOL USE [] DRUG USE [] HULL FAILURE [] MACHINERY FAILURE [] EQUIPMENT FAILURE [] OPERATOR INEXPERIENCE [] OPERATOR INATTENTION [] CONGESTED WATERS [] PASSENGER/SKIER BEHAVIOR [] DAM/LOCK [] OTHER (SPECIFY)	
ESTIMATED SPEED [] 10 - 20 MPH	[] NONE [] 21 - 40 MPH	[] UNDER 10 MPH [] OVER 40 MPH	[] HIT AND RUN				

Boating Accident Report

DECEASED (IF MORE THAN 2 FATALITIES, ATTACH ADDITIONAL FORMS)			
NAME OF VICTIM		ADDRESS OF VICTIM	
DATE OF BIRTH	[] MALE [] FEMALE	DEATH CAUSED BY	[] DROWNING [] OTHER [] DISAPPEARANCE
NAME OF VICTIM		ADDRESS OF VICTIM	
DATE OF BIRTH	[] MALE [] FEMALE	DEATH CAUSED BY	[] DROWNING [] OTHER [] DISAPPEARANCE
INJURED (IF MORE THAN 2 INJURIES, ATTACH ADDITIONAL FORMS)			
NAME OF VICTIM		ADDRESS OF VICTIM	
DATE OF BIRTH	MEDICAL TREATMENT BEYOND FIRST AID? [] YES [] NO ADMITTED TO HOSPITAL? [] YES [] NO	DESCRIBE INJURY	
WAS PFD WORN? [] YES [] NO	PRIOR TO ACCIDENT? [] YES [] NO	AS A RESULT OF ACCIDENT? [] YES [] NO	
WAS IT INFLATABLE? [] YES [] NO			
NAME OF VICTIM		ADDRESS OF VICTIM	
DATE OF BIRTH	MEDICAL TREATMENT BEYOND FIRST AID? [] YES [] NO ADMITTED TO HOSPITAL? [] YES [] NO	DESCRIBE INJURY	
WAS PFD WORN? [] YES [] NO	PRIOR TO ACCIDENT? [] YES [] NO	AS A RESULT OF ACCIDENT? [] YES [] NO	
WAS IT INFLATABLE? [] YES [] NO			
OTHER PEOPLE ABOARD THIS BOAT (IF MORE THAN 2 PEOPLE, ATTACH ADDITIONAL FORMS)			
NAME		ADDRESS	
DATE OF BIRTH	WAS PFD WORN? [] YES [] NO AS A RESULT OF ACCIDENT [] YES [] NO	PRIOR TO ACCIDENT? [] YES [] NO	WAS IT INFLATABLE? [] YES [] NO
NAME		ADDRESS	
DATE OF BIRTH	WAS PFD WORN? [] YES [] NO AS A RESULT OF ACCIDENT [] YES [] NO	PRIOR TO ACCIDENT? [] YES [] NO	WAS IT INFLATABLE? [] YES [] NO
BOAT NO. 2 (IF MORE THAN 2 VESSELS, ATTACH ADDITIONAL IDENTIFYING INFORMATION)			
NAME OF OPERATOR		OPERATOR ADDRESS	
OPERATOR TELEPHONE NUMBER ()		BOAT REGISTRATION OR DOCUMENTATION NUMBER	STATE
NAME OF OWNER		OWNER ADDRESS	
OWNER TELEPHONE NUMBER ()			
PROPERTY DAMAGE			
ESTIMATED AMOUNT: THIS BOAT AND CONTENTS:	OTHER BOAT(S) AND CONTENTS:	OTHER PROPERTY:	
\$	\$	\$	
DESCRIBE PROPERTY DAMAGED			
WITNESSES NOT ON THIS VESSEL			
NAME	ADDRESS	TELEPHONE NUMBER ()	
NAME	ADDRESS	TELEPHONE NUMBER ()	
PERSON COMPLETING REPORT			
NAME	ADDRESS	TELEPHONE NUMBER ()	
SIGNATURE	QUALIFICATION [] OPERATOR [] OWNER [] INVESTIGATOR [] OTHER	DATE SUBMITTED	
FOR AGENCY USE ONLY			
CAUSES BASED ON (CHECK ONE): [] THIS REPORT [] INVESTIGATION [] INVESTIGATION AND THIS REPORT [] OTHER			
NAME OF REVIEWING OFFICE	DATE RECEIVED	RECREATIONAL []	NON-REPORTABLE []
PRIMARY CAUSE	COMMERCIAL [] SECONDARY CAUSE		

Call the Coast Guard Infoline 1-800-368-5647 for information on **Federal Requirements for Recreational Boats**

Boating Accident Report

ACCIDENT DESCRIPTION

DESCRIBE WHAT HAPPENED (SEQUENCE OF EVENTS. INCLUDE FAILURE OF EQUIPMENT. INCLUDE A DIAGRAM IF NEEDED. CONTINUE ON ADDITIONAL SHEETS IF NECESSARY. INCLUDE ANY INFORMATION REGARDING THE INVOLVEMENT OF ALCOHOL AN/OR DRUGS IN CAUSING OR CONTRIBUTING TO THE ACCIDENT. INCLUDE ANY DESCRIPTIVE INFORMATION ABOUT THE USE OF PFD'S.)

An agency may not conduct or sponsor and a person is not required to respond to an information collection, unless it displays a currently valid OMB Control Number. The Coast Guard estimates that the average burden for this report form is 30 minutes. You may submit any comments concerning the accuracy of this burden estimate or any suggestions for reducing the burden to: Commandant (G-OPB-1), U.S. Coast Guard, Washington, DC 20593-0001 or Office of Management and Budget, Paperwork Reduction Project (2115-0010), Washington, DC 20503.

NOTES

Appendix E: FLOAT PLAN

Crevalle recommends filling out a float plan each time you use your boat for an offshore day trip or a long cruise. Leave this information with a responsible person ashore, like a close friend or relative that you know well.

1. Name of person reporting and telephone number.

2. Description of boat.

Type _____ Color _____ Trim _____
 Registration No. _____ Length _____
 Name _____ Make _____ Other Info _____

3. Engine type _____ H.P. _____
 No. of Engines _____ Fuel Capacity _____

4. Survival equipment: (Check as appropriate)

<input type="checkbox"/> PFDS	<input type="checkbox"/> Flares	<input type="checkbox"/> Mirror
<input type="checkbox"/> Smoke Signals	<input type="checkbox"/> Flashlight	<input type="checkbox"/> Food
<input type="checkbox"/> Paddles	<input type="checkbox"/> Water	<input type="checkbox"/> Others
<input type="checkbox"/> Anchor	<input type="checkbox"/> Raft or Dinghy	<input type="checkbox"/> EPIRB

5. Radio Yes No Type _____

6. Automobile license _____
 Type _____ Trailer License _____
 Color _____ and make of auto _____

7. Persons aboard _____
 Name _____ Age _____ Address & telephone No. _____

8. Do any of the persons aboard have a medical problem?
 Yes No If yes, what? _____

9. Trip Expectations: Leave at _____
 From _____ Going to _____
 Expect to return by _____ (time)
 and no later than _____

10. Any other pertinent info. _____

11. If not returned by _____ (time)
 call the COAST GUARD or (Local authority) _____

12. Telephone Numbers.

NOTES

Appendix F:

GLOSSARY OF TERMS

Aft: In, near, or toward the stern of a boat.

Aground: A boat stuck on the bottom.

Amidships: In or toward the part of a boat midway between the bow and stern.

Anchor: A specially shaped heavy metal device designed to dig efficiently into the bottom under a body of water and hold a boat in place.

Anchorage: An area specifically designated by governmental authorities in which boats may anchor.

Ashore: On shore.

Astern: Behind the boat, to move backwards.

Athwartship: At right angles to the center line of the boat.

Barnacles: Small, hard-shelled marine animals which are found in salt water attached to pilings, docks and bottoms of boats.

Beam: The breadth of a boat usually measured at its widest part.

Bearing: The direction of an object from the boat, either relative to the boat's direction or to compass degrees.

Berth: A bunk or a bed on a boat.

Bilge: The bottom of the boat below the flooring.

Bilge Pump: A pump that removes water that collects in the bilge.

Boarding: Entering or climbing into a boat.

Boarding Ladder: Set of steps temporarily fitted over the side of a boat to assist persons coming aboard.

Boat Hook: Short shaft of wood or metal with a hook fitting at one end shaped to aid in extending one's reach from the side of the boat.

Bow: The front end of a boat's hull.

Bow Line: A line that leads forward from the bow of the boat.

Bow Rail: Knee high rails of solid tubing to aid in preventing people from falling overboard.

Bridge: The area from which a boat is steered and controlled.

Bridge Deck: A deck forward and usually above the cockpit deck.

Broach: When the boat is sideways to the seas and in danger of capsizing; a very dangerous situation that should be avoided.

Bulkhead: Vertical partition or wall separating compartments of a boat.

Cabin: Enclosed superstructure above the main deck level.

Capsize: When a boat lays on its side or turns over.

Chock: A deck fitting, usually of metal, with inward curving arms through which mooring or anchor lines are passed so as to lead them in the proper direction both onboard and off the boat.

Cleat: A deck fitting, usually of metal with projecting arms used for securing anchor and mooring lines.

Closed Cooling System: A separate supply of fresh water that is used to cool the engine and circulates only within the engine.

Coaming: A vertical piece around the edges of cockpit, hatches, etc. to stop water on deck from running below.

Cockpit: An open space, usually in the aft deck, outside of the cabin.

Companionway: Opening in the deck of a boat to provide access below.

Glossary of Terms

Compartment: The interior of a boat divided off by bulkheads.

Cradle: A framework designed to support a boat as she is hauled out or stored.

Cutlass Bearing: A rubber bearing in the strut that supports the propeller shaft.

Deck: The floor-like platform of a boat that covers the hull.

Displacement: The volume of water displaced by the hull. The displacement weight is the weight of this volume of water.

Draft: The depth of water a boat needs to float.

Dry Rot: A fungus attack on wood areas.

Dry-dock: A dock that can be pumped dry during boat construction or repair.

Electrical Ground: A connection between an electrical connector and the earth.

Engine Beds: Sturdy structural members running fore and aft on which the inboard engines are mounted.

EPIRB: Emergency Position Indicating Radio Beacon. Operates as a part of a worldwide satellite distress system.

Even Keel: When a boat floats properly as designed.

Fathom: A measure of depth. One Fathom = 6 feet.

Fender: A soft object of rubber or plastic used to protect the topsides from scarring and rubbing against a dock or another vessel.

Fend off: To push or hold the boat off from the dock or another boat.

Flying Bridge: A control station above the level of the deck or cabin.

Flukes: The broad portions of an anchor which dig into the ground.

Fore: Applies to the forward portions of a boat near the bow.

Foundering: When a boat fills with water and sinks.

Freeboard: The height from the waterline to the lowest part of the deck.

Galley: The kitchen of a boat.

Grab Rail: Hand hold fittings mounted on cabin tops or sides for personal safety when moving around the boat, both on deck and below.

Ground Tackle: A general term including anchors, lines, and other gear used in anchoring.

Grounds: A boat touches the bottom.

Gunwale: The upper edge of a boat's side.

Hand Rail: Rail mounted on the boat, for grabbing with your hand, to steady you while walking about the boat.

Harbor: An anchorage which provides reasonably good protection for a boat, with shelter from wind and sea.

Hatch: An opening in the deck with a door or lid to allow for access down into a compartment of a boat.

Head: A toilet on a boat.

Heat Exchanger: Used to transfer the heat that is picked up by the closed cooling system to the raw cooling water.

Helm: The steering and control area of a boat.

Hull: The part of the boat from the deck down.

Inboard: A boat with the engine mounted within the hull of the boat. Also refers to the center of the boat away from the sides.

Inboard/outboard: Also stern drive or I/O. A boat with an inboard engine attached to an outboard drive unit.

Keel: A plate or timber plate running lengthwise along the center of the bottom of a boat.

Knot: Unit of speed indicating nautical miles per hour. 1 knot = 1 nautical mile per hour (1.15 miles per hour). A nautical mile is equal to one minute of latitude: 6076 feet. Knots times 1.15 equals miles per hour. Miles per hour times .87 equals knots.

Lay-up: To decommission a boat for the winter (usually in northern climates).

Leeward: The direction toward which the wind is blowing.

Length On The Waterline (l.w.l.): A length measurement of a boat at the waterline from the stern to where the hull breaks the water near the bow.

Limber Hole: A passage cut into the lower edges of floors and frames next to the keel to allow bilge water to flow to the lowest point of the hull where it can be pumped overboard.

Line: The term used to describe a rope when it is on a boat.

Lists: A boat that inclines to port or starboard while afloat.

L.O.A.: Boat length overall.

Locker: A closet, chest or box aboard a boat.

Loran: An electronic navigational instrument which monitors the boat's position using signals emitted from pairs of transmitting stations.

Lunch hook: A small light weight anchor typically used instead of the working anchor. Normally used in calm waters with the boat attended.

Midships: The center of the boat.

Marina: A protected facility primarily for recreational small craft.

Marine Ways or Railways: Inclined planes at the water's edge onto which boats are hauled.

Moored: A boat secured with cables, lines or anchors.

Mooring: An anchor permanently embedded in the bottom of a harbor that is used to secure a boat.

Nautical Mile: A unit of measure equal to one minute of latitude. (6076 feet)

Nun Buoy: A red or red-striped buoy of conical shape.

Outboard: A boat designed for an engine to be mounted on the transom. Also a term that refers to objects away from the center line or beyond the hull sides of a boat.

Pad Eye: A deck fitting consisting of a metal eye permanently secured to the boat.

Pier: A structure which projects out from the shoreline.

Pile or Piling: A long column driven into the bottom to which a boat can be tied.

Pitching: The fore and aft rocking motion of a boat as the bow rises and falls.

Pitch: The measure of the angle of a propeller blade. Refers to the theoretical distance the boat travels with each revolution of the propeller.

P.F.D.: Personal Flotation Device.

Port: The left side of the boat when facing the bow.

Porthole (port): The opening in the side of a boat to allow the admittance of light and air.

Propeller: A device having two or more blades that is attached to the engine and used for propelling a boat.

Propeller Shaft: Shaft which runs from the back of the engine gear box, aft, through the stuffing box, shaft log, struts, and onto which the propeller is attached.

Pyrotechnic Distress Signals: Distress signals that resemble the brilliant display of flares or fireworks.

Glossary of Terms

Raw Water Cooled: Refers to an engine cooling system that draws seawater in through a hull fitting or engine drive unit, circulates the water in the engine, and then discharges it overboard.

Reduction Gear: Often combined with the reverse gear so that the propeller turns at a slower rate than the engine.

Reverse Gear: Changes the direction of rotation of the propeller to provide thrust in the opposite direction for stopping the boat or giving it sternway.

Roll: A boat's sideways rotational motion in rough water.

Rope Locker: A locker, usually located in the bow of a boat, used for stowing the anchor line or chain.

Rubrail: Railing (often rubber or hard plastic) that runs along the boat's sheer to protect the hull when coming alongside docks, piers, or other boats.

Rudder: A moveable flat surface that is attached vertically at or near the stern for steering.

Sea anchor: An anchor that does not touch the bottom. Provides drag to hold the bow in the most favorable position in heavy seas.

Scupper: An opening in the hull side or transom of the boat through which water on deck or in the cockpit is drained overboard.

Sea cock: Safety valves installed just inside the thru-hull fittings and ahead of the piping or hose running from the fittings.

Shaft Log: Pipe through which the propeller shaft passes.

Sheer: The uppermost edge of the hull.

Sling: A strap which will hold the boat securely while being lifted, lowered, or carried.

Slip: A boat's berth between two pilings or piers.

Sole: The deck of a cockpit or interior cabin.

Spring Line: A line that leads from the bow aft or from the stern forward to prevent the boat from moving ahead or astern.

Starboard: The right side of a boat when facing the bow.

Steerageway: Sufficient speed to keep the boat responding to the rudder or drive unit.

Stem: The vertical portion of the hull at the bow.

Stern: The rear end of a boat.

Stow: To pack away neatly.

Stringer: Longitudinal members fastened inside the hull for additional structural strength.

Strut: Mounted to the hull which supports the propeller shaft in place.

Strut Bearing: See "cutlass bearing."

Stuffing Box: Prevents water from entering at the point where the propeller shaft passes through the shaft log.

Superstructure: Something built above the main deck level.

Swamps: When a boat fills with water from over the side.

Swimming Ladder: Much the same as the boarding ladder except that it extends down into the water.

Taffrail: Rail around the rear of the cockpit.

Thru-hull: A fitting used to pass fluids (usually water) through the hull surface, either above or below the waterline.

Topsides: The side skin of a boat between the waterline or chine and deck.

Transom: A flat stern at right angles to the keel.

Travel Lift: A machine used at boat yards to hoist boats out of and back into the water.

Trim: Refers to the boat's angle or the way it is balanced.

Glossary of Terms

Trough: The area of water between the crests of waves and parallel to them.

Twin-Screw Craft: A boat with two propellers on two separate shafts.

Underway: When a boat moves through the water.

Wake: Disrupted water that a boat leaves astern as a result of its motion.

Wash: The flow of water that results from the action of the propeller or propellers.

Waterline: The plane of a boat where the surface of the water touches the hull when it is afloat on even keel.

Watertight Bulkhead: Bulkheads secured so tightly so as not to let water pass.

Wharf: A structure generally parallel to the shore.

Working Anchor: An anchor carried on a boat for most normal uses. Refers to the anchor used in typical anchoring situations.

Windlass: A winch used to raise and lower the anchor.

Windward: Toward the direction from which the wind is coming.

Yacht Basin: A protected facility primarily for recreational small craft.

Yaw: When a boat runs off her course to either side.

NOTES

TROUBLESHOOTING GUIDE

PROBLEM	CAUSE AND SOLUTION
CONTROL SYSTEMS	
Hydraulic Steering is slow to respond & erratic.	<ul style="list-style-type: none"> • Steering system is low on fluid. Fill and bleed system. • Steering system has air in it. Fill and bleed system. • A component in the steering system is binding. Check and adjust or repair binding component. • Engine steering spindle is binding. Grease spindle.
The boat wanders and will not hold a course at cruise speeds.	<ul style="list-style-type: none"> • There could be air in the steering system. Fill & bleed the system. • The engine steering tab is corroded or out of adjustment. Replace or adjust steering tab. • Engine steering spindle is binding. Grease spindle.
Hydraulic Steering is unusually hard.	<ul style="list-style-type: none"> • The fuse or circuit breaker for the power steering circuit has blown or tripped. Replace the fuse or reset the breaker. • An internal fuse in the power steering pump system has blown. Refer to the steering owners manual for fuse location and replace the fuse or contact your dealer for assistance. • A steering line is kinked or collapsed. Replace kinked or collapsed line.
An engine will not start with the shift control lever in neutral.	<ul style="list-style-type: none"> • The control cable is out of adjustment & not activating the neutral safety cut out switch. • The shift control lever is not in the neutral detent. Try moving the shift lever slightly. • There is a loose wire on the neutral safety switch on the control. Inspect wires and repair loose connections. • The starter or ignition switch is bad. • There is a problem with the electronic control system at the helm control, module or at the engine. Have the system serviced by a qualified marine technician.
PERFORMANCE PROBLEMS	
Boat is sluggish and has lost speed & RPM.	<ul style="list-style-type: none"> • The boat may be need to have marine growth cleaned from hull and running gear. • Propellers may be damaged & need repair. • Weeds or line around the propellers. Clean propellers. • Boat is overloaded. Reduce load. • Check for excessive water in the bilge. Pump out bilge & find & correct the problem. • The throttle adjustment has changed and the engine is not getting full throttle. Adjust the throttle cable. • One of the throttle is not responding properly and the engine is not getting full throttle. Have the throttle control checked by a qualified marine technician.

Troubleshooting Guide

PROBLEM	CAUSE AND SOLUTION
PERFORMANCE PROBLEMS	
<p>The boat vibrates at cruising speeds.</p>	<ul style="list-style-type: none"> • Propellers may be damaged & need repair. • A propeller or propeller shaft is bent. Repair or replace damaged components. • The running gear is fouled by marine growth or rope. Clean running gear. • The engines are not trimmed properly. Trim engines.
ENGINE PROBLEMS	
<p>An engine is running too hot.</p>	<ul style="list-style-type: none"> • The engine raw water pick up strainer is clogged with marine growth. Clean pick up. • The engine raw water pump impeller is worn or damaged. Repair the pump. • The engine thermostat is faulty and needs to be replaced.
<p>An engine alternator is not charging properly.</p>	<ul style="list-style-type: none"> • The battery cable is loose or corroded. Clean and tighten battery cables. • The alternator is not charging and must be replaced. • The battery is defective. Replace the battery.
<p>An engine suddenly will not operate over 2000 RPM.</p>	<ul style="list-style-type: none"> • The engine emergency system has been activated. The onboard computer has sensed a problem and has limited the RPM to protect the engine. Find & correct the problem. • The tachometer is bad and needs to be replaced. • A throttle control is not responding properly. Have the throttle setting checked by a qualified technician.
<p>An engine is loosing RPM. The boat is not overloaded and the hull bottom and running gear are clean and in good condition.</p>	<ul style="list-style-type: none"> • The engine may be having a problem with a sticky Anti-siphon valve, located in the fuel line near the fuel tank, that is restricting the fuel flow. Remove & clean or replace the anti-siphon valve. • The remote gasoline fuel filter could be dirty. Inspect and replace the fuel filter. • The primary fuel filter on the engine may be dirty. Inspect and replace the fuel filter. • The electronic engine control system on the engine is malfunctioning. Repair the engine control system. • The fuel injection system on the engine is malfunctioning. Repair the fuel injection system.

PROBLEM	CAUSE AND SOLUTION
ACCESSORY PROBLEMS	
A livewell pump runs, but does not pump water.	<ul style="list-style-type: none"> • The sea chest supply valves are not open. Open valves. • The sea chest intake strainers are clogged with weeds or debris. Clean the intake sea strainers. • The baitwell supply valve is not open. Open the valve. • There is an air lock in the system. Prime the system.
The fresh water pump runs, but will not pump water.	<ul style="list-style-type: none"> • The water tank is empty. Fill the tank. • The intake hose is damaged and sucking air. Replace or repair the hose. • The pump is defective. Repair or replace the pump.
The fishbox pump out pump runs, but does not pump out the fishbox.	<ul style="list-style-type: none"> • The drain fitting in the fishbox is clogged. Clean the fitting. • The pump has an air lock. Fill the fishbox half full of water, then turn the pump on and off several times to move the air out and prime the pump. • The pump discharge line is clogged. Clean the discharge line. • The pump is defective. Repair or replace the pump.
The fresh water pump fails to turn off after all outlets are closed.	<ul style="list-style-type: none"> • There is a leak in a pressure line or outlet. Repair the leak. • There is an air leak in the intake line. Repair the air leak. • The pressure switch is defective. Replace the pressure switch. • The voltage to the pump is low. Check for corroded or loose wiring connections or low battery. • The strainer is clogged. Clean strainer. • The pump is defective. Repair or replace the pump.
The washdown pump runs, but the pump will not pump water.	<ul style="list-style-type: none"> • The thru-hull valve is not open. Open valve. • The in-line sea strainer for the pump is clogged. Clean the sea strainer.
The washdown or fresh water pump fails to turn off after all outlets are closed.	<ul style="list-style-type: none"> • The intake hose is damaged and sucking air. Replace hose. • The pump is defective. Repair or replace the pump. • There is a leak in a pressure line or outlet. Repair the leak. • There is an air leak in the intake line. Repair the air leak. • The pressure switch is defective. Replace the pressure switch. • The voltage to the pump is low. Check for corroded or loose wiring connections or low battery.
Reduction in water flow from the bilge pump.	<ul style="list-style-type: none"> • The strainer is clogged. Clean strainer. • The pump is defective. Repair or replace the pump. • Impeller screen plugged with debris. Clean screen at the base of the pump. • The discharge hose is pinched or clogged. Check discharge hose and clean or repair. • Low voltage to the pump. Check the battery and wire connections.

Troubleshooting Guide

PROBLEM	CAUSE AND SOLUTION
ACCESSORY PROBLEMS	
<p>The automatic switch on the bilge pump does not activate the pump .</p>	<ul style="list-style-type: none"> • The fuse or circuit breaker for the automatic switch has tripped or blown. Replace the fuse or reset the circuit breaker. • The battery is dead. Charge or replace the battery. • The pump impeller is jammed by debris. Clean pump impeller housing. • The wire connections in the bilge have corroded. Replace connectors and secure above the bilge waterline. • The automatic switch is defective. Replace the switch. • The pump is defective. Replace pump.
<p>The bilge pump will not run when the manual switch is activated.</p>	<ul style="list-style-type: none"> • The circuit breaker supplying the switch has tripped. Reset the circuit breaker. Replace if defective. • The battery switch is off. Turn on the battery switch. • The pump impeller is jammed by debris. Clean pump impeller housing. • The wire connections in the bilge have corroded. Replace connectors and secure above the bilge waterline. • The switch is defective. Replace the switch. • The pump is defective. Replace pump.
<p>Head will not flush.</p>	<ul style="list-style-type: none"> • The holding tank is full. Pump out the holding tank. • The flush valve is defective. Replace the flush valve.
<p>Excessive odor from marine head.</p>	<ul style="list-style-type: none"> • Back pressure in the holding tank. Pump out holding tank and clean the vent and vent hose. • No deodorizer in the holding tank. Add deodorizer to the holding tank each time it is pumped out. • The waste in the tank is over two weeks old. Pump the holding tank if it has contained waste for two weeks or more.
<p>Holding tank will not empty.</p>	<ul style="list-style-type: none"> • Holding tank vent is clogged. Clean the vent and vent hose. • There is a vacuum leak in the hose from the holding tank to the deck pump out fitting. Tighten loose fittings or replace damaged hoses.
<p>No AC power to the battery charger and shore cord is properly connected.</p>	<ul style="list-style-type: none"> • The breaker at the shore outlet is off. Activate breaker. • The shore power cord is damaged or defective. Replace the cord. • The shore inlet connection is corroded or defective. Replace the inlet connection.

Appendix H: SPECIFICATIONS

332 CSF Specifications

HULL LENGTH OVERALL W/ PLATFORM _____ 33' 2" / 10.11 m

BEAM _____ 10' 6" / 3.20 m

WEIGHT DRY - NO ENGINES _____ 9,000 lb / 4,082.33 kg

DEAD RISE _____ 20°

DRAFT _____ 20"-22" / .51 l -.56 l

FUEL CAPACITY _____ 300 gal / 1135.62 l

WATER TANK CAPACITY _____ 30 gal / 113.56 l

WASTE TANK CAPACITY _____ 14 gal / 53 l

MAXIMUM HORSEPOWER _____ 900 hp / 671.12 kw

Notice:

Dry weight is the average weight of the base boat without engines, fuel, water, waste or gear.

Specifications and weights are approximate and may differ from boat to boat.



Crevalle Boats
Littoral Marine LLC
1520 Industrial Drive
Wildwood, FL 34785

Rev. 0 10-23-2020